

Selection Guide | VLT® HVAC Drive FC 102 | 1.1 – 400 kW

Drive down operating costs,
with the leader in **HVAC efficiency**

98%

Energy efficiency
Save energy and
money with HVAC-
optimized drives.

VLT®
HVAC Drive





Dedicated drive for highest energy efficiency and reliability

The VLT® HVAC Drive FC 102 is a dedicated, globally supported drive that combines flexibility and efficiency in a package designed to minimize total system and lifecycle costs in HVAC applications.

Designed to provide the highest efficiency solution with induction, SynRM and PM motors from all major suppliers, the VLT® HVAC Drive is the leading drive for heating, ventilation and air conditioning systems. The motor-independent drive can be installed in any fan or pump system and provide years of reliable, maintenance free operation.

When used in Danfoss' EC+ concept, the HVAC drive plays a significant part in enabling building owners to meet ever- stricter efficiency and environmental legislation effectively and cost efficiently.

Every VLT® HVAC Drive is based on 30 years of experience and innovation. Easy to use, all models follow the same basic design and operating principle. Once you know one, you know them all. This selection guide helps you to choose and configure your perfect drive for applications from 1.1-400 kW.

**Drive power sizes up to 1.4 MW are
handled in a separate brochure**



GLOBAL REACH

Danfoss' efficient global logistics setup makes it possible to ship VLT® drives quickly to any destination.

Danfoss' global support organization is geared to react swiftly to resolve issues to help you reduce downtime. In the event of issues Danfoss' global hotline helps you find the right solution quickly and efficiently.

In order to provide fast support in major industrial areas Danfoss is also present with highly trained, dedicated professionals. Based close to chemical hotspots, marine hubs and major industrial areas around the world, Danfoss experts are ready to provide fast access to drive and application expertise.

TRAINING BASED ON EXPERIENCE

Keep up to date on trends, methods and features that save additional energy or offer new technical opportunities to increase your product quality or decrease the downtime of your plant.

Receive the same high-quality training anywhere in the world with Danfoss-developed material and trainers. Training can take place at one of Danfoss' facilities or directly at the customer's own facility. Teaching is conducted by local trainers who have broad experience in the many conditions that may affect performance, so you get the most out of your Danfoss solution.

Additionally, the online platform Danfoss Learning offers you the opportunity to extend your knowledge in small and compact lessons up to extensive training courses, when and wherever you want.

Read more at learning.danfoss.com

Flexible, modular and adaptable

Built to last

The VLT® HVAC Drive is built on a flexible, modular design concept to provide an extraordinarily versatile motor control solution. Equipped with a wide range of HVAC features, owners can achieve optimal fan and pump control, higher quality output and, reduce costs related to spare parts and service, and much more.

Built-in EMC filters

VLT® HVAC Drive units are equipped with integrated DC link chokes and EMC filters as standard features. This enables them to reduce grid pollution and eliminate the cost and effort of fitting external EMC components and related wiring.

Reduce costs with compact drives

A compact design and efficient heat management mean the drives take up less space in control rooms and panels in all kinds of environments. Especially impressive is the 315 kW, 400 V version, which is among the smallest in its power class on the market today, and is available in an IP54 enclosure.

Compact dimensions are also an advantage in applications where drive space is restricted. This makes it possible for designers to develop smaller applications without being forced to compromise on protection and grid quality. For example, the VLT® HVAC Drive FC 102 drives rated 110-400 kW are 25-68% smaller than equivalent drives.

The IP20 version is optimized for cabinet mounting and features covered power terminals to prevent accidental contact. The unit can also be ordered with optional fuses or circuit breakers

in the same package size. Control and power cables are fed in separately at the bottom.

The AC drives combine a flexible system architecture, which allows them to be adapted to specific applications, with a uniform user interface across all power classes. This allows you to adapt the drive to the exact needs of your specific application.

As a result project work and costs are subsequently reduced. The easy to use interface reduces training requirements. The integrated SmartStart guides users quickly and efficiently through the setup process, which results in fewer faults due to configuration and parameterization errors.

Freedom to design efficient systems

HVAC drives are built on a flexible system architecture, which allows them to be adapted to specific applications to provide maximum system efficiency.

Available in a performance range from 1.1 kW to 1.4 MW the FC 102 series can control nearly all standard industrial motor technologies, including permanent magnet motors, copper rotor motors, direct line PM and SynRM (high-efficiency synchronous reluctance) motors.

The AC drive is designed to work with all common supply voltages: 200 V, 380-480 V, 525-600 V and 690 V.

As a result, system designers, OEMs and end users can connect the drive to their chosen motor and reduce project costs with a solution that performs to the highest standards.

Up to
50°C
ambient
temperature
without derating.



VLT® PLATFORM HIGHLIGHTS

- **Versatile, flexible, configurable**
- **EMC filters integrated as standard**
- **Induction, PM and SynRM motor control**
- **9 fieldbuses supported**
- **Up to 1.4 MW in common voltages**
- **Unique user interface**
- **Globally supported**

Size and protection rating

The perfect fit for your application

All Danfoss VLT® drives follow the same design principle for fast, flexible and fault-free installation and efficient cooling.

VLT® HVAC Drive is available in a broad range of enclosure sizes and protection ratings from IP20 to IP66 to enable easy installation in all environments: mounted in panels, switch rooms or as stand-alone units for heating, ventilation and air conditioning.

Cost saving heat management

In VLT® HVAC Drive the cooling air and the internal electronics are separated, protecting electronics

from contaminants. At the same time the construction removes heat efficiently which helps to prolong product life, increase the overall availability of the system and reduce faults related to high temperatures.

For example, by exhausting heat directly outside it is possible to reduce the size of the cooling system in the panel or switch room. This can be achieved with Danfoss' panel through cooling system or the extremely

efficient back-channel cooling concept, that directs heat outside the control room. Both methods make it possible to reduce the initial cost of the panel or switch room.

In daily use the benefits are equally clear as the energy consumption related to cooling can be reduced significantly. This means that designers can reduce the size of the air conditioning system, or even eliminate it entirely.

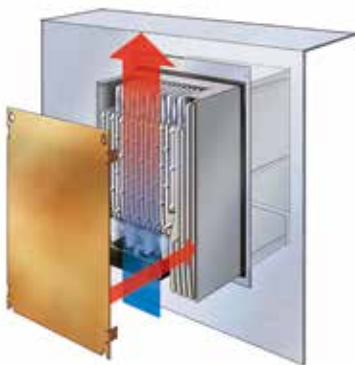

Panel through cooling

An accessory mounting kit for small and mid-range drives enables heat losses to be directed directly outside the panel room.



Back-channel cooling

By directing air through a rear cooling channel up to 85-90% of the drive's heat loss is removed directly outside the installation room.



No air over electronics

Complete separation between cooling air and the internal electronics ensures efficient cooling.



VLT® HVAC Drives are available in IP20 enclosures optimized for installation in panels. For use in harsh environments choose IP54 (110 kW and above), IP55 or IP66 enclosures.

Coated circuit boards

The electronic components are coated in conformance to IEC 60721-3-3, class 3C2, as standard.

If used in especially harsh conditions, it is possible to order a special coating that complies with class 3C3.

Ruggedized for extra protection

The VLT® HVAC Drive is available in a 'ruggedized' version, that ensures that components remain firmly in place in environments characterized by high degrees of vibration, such as marine and mobile equipment.

RETROFITTING. FAST UPGRADE TO NEWEST TECHNOLOGY PLATFORM



As technologies evolve and newer, smaller and more efficient models replace old drives, it is important to Danfoss that you can change and upgrade as easily as possible. Minimize downtime in your production and update your installation in a few minutes with prepared tools from Danfoss. With a Danfoss conversion kit it is easy and fast to prepare your application for the future:

- *Mechanical adaptation*
- *Electric adaptation*
- *Parameter adaptation*



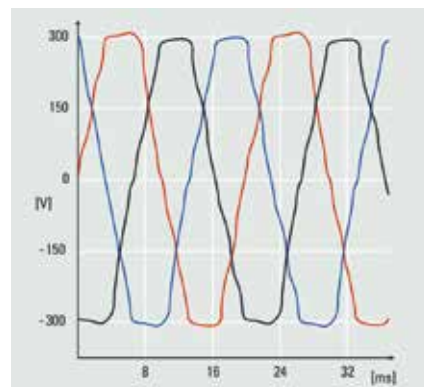

Harmonic distortion

Electrical interference reduces efficiency and risks harming equipment.

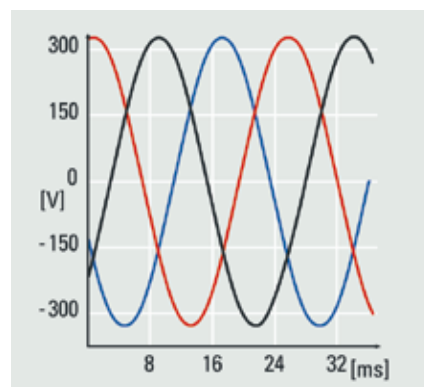

Optimized harmonic performance

Efficient harmonic mitigation protects electronics and increases efficiency.



Danfoss **VLT® HVAC Drives** are equipped with DC chokes that reduce mains interference to a THDi of 40%.

Optimize performance and grid protection

Built-in protection as standard

The VLT® HVAC Drive FC 102 contains all modules necessary for compliance with EMC standards.

A built-in scalable RFI filter minimizes electromagnetic interference. Integrated DC chokes reduce harmonic distortion in the mains network, which increases the lifetime of the DC link capacitors and therefore the drive system's overall efficiency.

The solutions save cabinet space, as they are integrated in the drive from the factory. Efficient EMC mitigation also enables the use of cables with smaller cross-sections, which again reduces installation costs.

Expand grid protection with filter solutions

If needed, Danfoss' wide range of solutions for harmonic mitigation can provide additional protection, such as the

- VLT® Advanced Harmonic Filter AHF
- VLT® Advanced Active Filter AAF
- VLT® Low Harmonic Drives
- 12-pulse VLT® drives

Provide motor protection with:

- VLT® Sine Wave Filter
- VLT® dU/dt Filter

With this solutions you achieve optimum performance for your application, even in weak or unstable grids.

Use motor cables up to 300 m

The design of the VLT® HVAC Drive makes it a perfect choice in applications that require long motor cables. Without needing additional components the drive provides trouble free operation with cable lengths of up to 150 m screened or 300 m unscreened. This allows the drive to be installed in a central control room a distance away from the application without affecting motor performance.

EMC Standards		Conducted emission		
Standards and requirements	EN 55011 <i>Facility operators must comply with EN 55011</i>	Class B Housing and light industries	Class A Group 1 Industrial environment	Class A Group 2 Industrial environment
	EN/IEC 61800-3 <i>Converter manufacturers must comply to EN 61800-3</i>	Category C1 First environment, home and office	Category C2 First environment, home and office	Category C3 Second environment
FC 102 compliance ¹⁾		■	■	■

¹⁾ Compliance to mentioned EMC classes depends on the selected filter

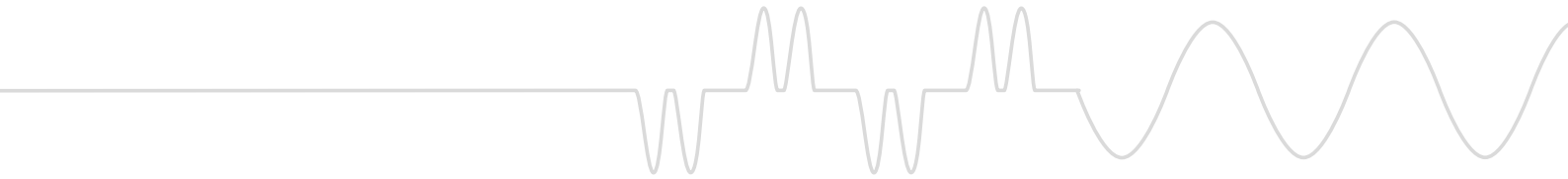



Increase safety

Fire override mode

Activating the function “Fire-mode” within the VLT® drive ensures secure and continued operation within applications such as stair-well pressurization, car park exhaust fans, smoke exhaust and essential service functions.

Drive bypass

If a drive bypass is available the VLT® HVAC Drive will not only sacrifice itself; it will also bypass itself and connect the motor directly to mains. As a result fan functionality will be maintained after the drive fails, as long as there is power and the motor is functioning.
(only available in the USA)

Protect applications and operators

The VLT® HVAC Drive FC 102 is able to provide the STO (Safe Torque Off) function in compliance with ISO 13849-1 PL d and SIL 2, according to IEC 61508/IEC 62061. In high demand

applications this can be expanded with the VLT® Safe Option MCB 140, an external module that provides functions such as Safe Stop 1 (SS1),

Safely Limited Speed (SLS) and Safe Maximum Speed (SMS), control of external contactors and safety door monitoring and unlocking.

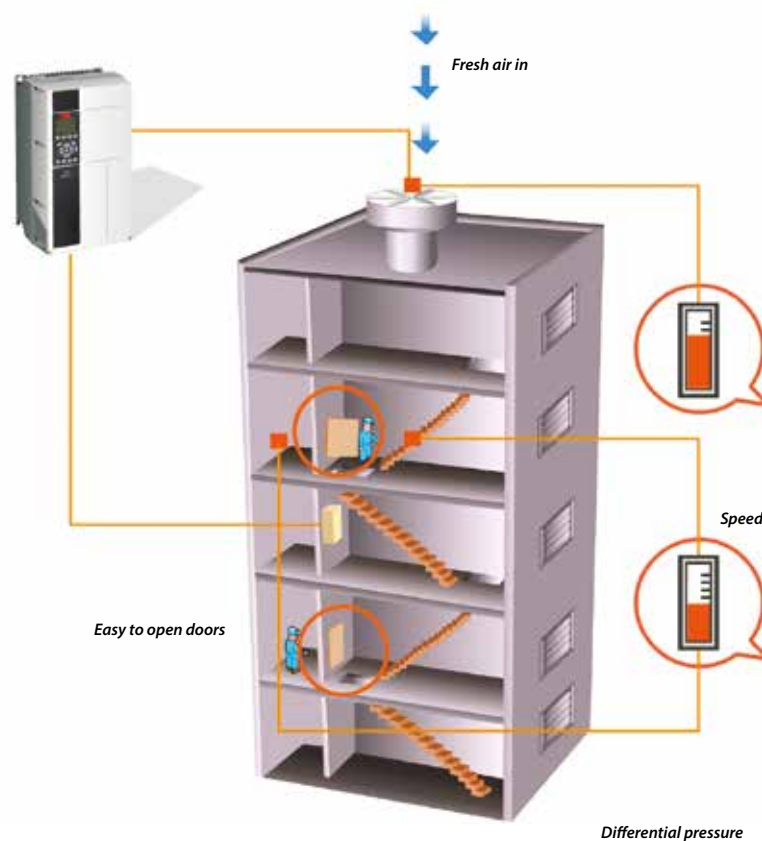



Nine fieldbuses supported

Increase productivity

With the wide range of fieldbus options the VLT® HVAC Drive can be easily connected to the fieldbus system of your choice. This makes the HVAC Drive a future-ready solution that can easily be expanded and updated if your needs change.

Danfoss fieldbus options can also be installed as a plug-and-play solution at a later stage, if the production layout demands a new communication platform. This way, you can be confident that you can optimize your plant without being forced to replace your existing drive system.

See the complete list of fieldbuses on page 24.

BACnet Change of Value (COV)

The standard, passive, BACnet protocol that is embedded in every HVAC drive, can be expanded with the VLT® BACnet MCA 109 option.

This add-on enables the drive to support COV. As a result the drive will only communicate if pre-defined set-points are exceeded.

By effectively optimizing communication, the MCA 109 reduces the load on the fieldbus enabling more efficient building management.

VLT® BACnet/IP MCA 125

The VLT® BACnet/IP MCA 125 option optimizes the use of VLT® HVAC Drive together with building management systems (BMS) using the BACnet/IP protocol or running BACnet on Ethernet. The option has two Ethernet connectors, enabling daisy-chain configuration with no need for external switches. The VLT® BACnet/IP MCA 125 makes it easy to control or monitor points required in typical HVAC applications, and reduces overall cost of ownership.

Besides standard functionality, the option provides six additional features:

- COV, Change Of Value
- Read/WritePropertyMultiple
- Alarm/Warning notifications
- PID Loop object
- Segmented data transfer
- Trending

These features give the programmer fast access to information while commissioning, and lower the net load traffic on the network. In this way, the MCA 125 option ensures the best possible performance and lowers the cost of the BACnet installation.





Energy documentation

VLT® Energy Box software is the most modern and advanced energy calculation tool available.

It allows energy consumption calculations and comparisons of HVAC fans, pumps and cooling tower applications driven by Danfoss drives and alternative methods of flow control.

The program compares the total operational costs of various traditional systems to operation of the same systems with a VLT® HVAC Drive.

With this program it is easy to evaluate the savings by comparing a VLT® HVAC Drive over other types of capacity control systems in both new installations as well as retrofit situations.

Complete financial analysis

VLT® Energy Box provides a complete financial analysis including:

- Initial cost for the drive system and the alternative system
- Installation and hardware costs
- Annual maintenance costs and any utility company incentives for energy conservation products
- Payback time and accumulated savings
- Upload of actual energy consumption (kWh) and duty cycle from the VLT® HVAC Drive

VLT® Energy Box makes it possible to capture actual energy data from the drives and monitor energy consumption and overall system efficiency.

Energy audit

The VLT® HVAC Drive coupled with Energy Box software enables the package to be used as the Energy Audit equipment for both the estimation and validation of savings.

VLT® HVAC Drive can be interrogated remotely for full energy data, making it easy to monitor your energy savings and return on investment. Monitoring via fieldbus often makes energy meters ommissible.

Download VLT® Energy Box
drives.danfoss.com/services/pc-tools/

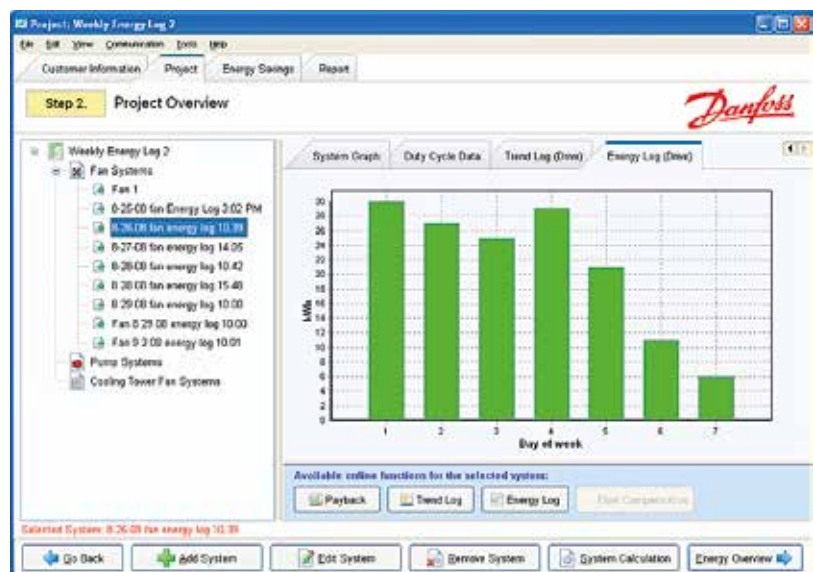



Software tools

VLT® Motion Control Tool MCT 10

VLT® Motion Control Tool MCT 10 is a windows-based engineering tool with a clearly structured interface that provides an instant overview of all the AC drives in a system of any size. The software runs under Windows and enables data exchange over a traditional RS485 interface, fieldbus (PROFIBUS, Ethernet, or other) or via USB.

Parameter configuration is possible both online on a connected drive and offline in the tool itself. Additional documentation, such as electrical diagrams or operating manuals, can be embedded in VLT® Motion Control Tool MCT 10. This reduces the risk of incorrect configuration while offering fast access to troubleshooting.

Download at <http://drives.danfoss.com/services/pc-tools/>

Danfoss HCS

Danfoss HCS is a professional harmonics simulation tool which is web-based. It provides harmonic analysis of systems using VLT® and VACON® products. This tool uses a scientific simulation platform with an advanced simulation model. It takes more system parameters into account, than the other harmonics simulation tools offered by Danfoss Drives, and therefore delivers more accurate results. Danfoss HCS presents the results of the simulation in table or graphical form.

Contact your local Danfoss sales office or visit our website for more information or visit directly at www.danfoss-hcs.com

VLT® Motion Control Tool MCT 31

This harmonics calculation software is designed to quickly assess the loads placed on the system by AC drives in the planning phase. This allows suitable measures to be taken to correct the system harmonics in advance.

VLT® Motion Control Tool MCT 31 calculates system harmonic distortion for both Danfoss and non-Danfoss AC drives, and calculates the effects of using various harmonic mitigation measures, including Danfoss harmonic filters.

Use VLT® Motion Control Tool MCT 31 in the planning phase to determine whether harmonics will be an issue

in your installation, and if so, which strategy is most cost-effective in addressing the problem.

Download at <http://drives.danfoss.com/services/pc-tools/>

Danfoss ecoSmart™

This online tool and app makes it easy to determine IE and IES classes according to EN 50598-2, for VLT® and VACON® drives alone and in combination with a motor.

Danfoss ecoSmart™ uses nameplate data to perform the efficiency calculations, and produces a pdf report for documentation.

Find Danfoss ecoSmart™ at <http://ecosmart.danfoss.com>

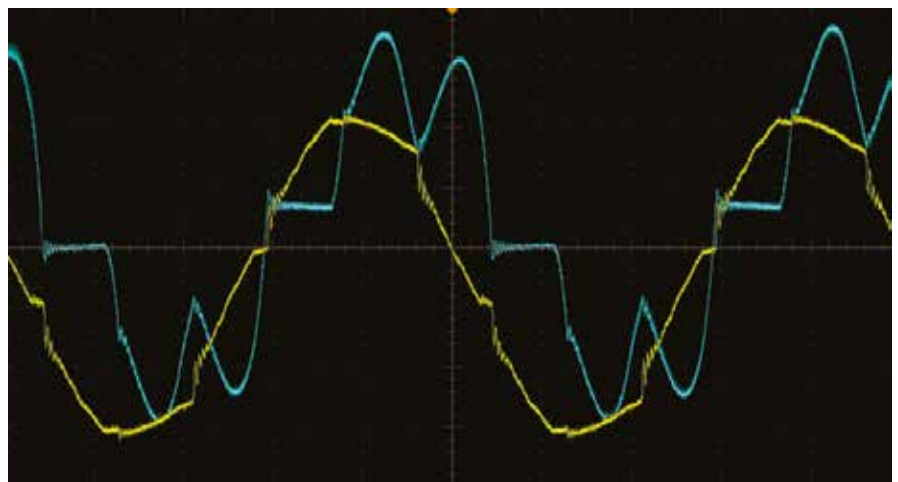

VLT® Motion Control Tool MCT 10 has integrated scope functionality to support monitoring and diagnosis of parameters.



Intuitive setup with graphical interface



The VLT® HVAC Drive features a user-friendly, hot-pluggable local control panel (LCP) for easy setup and parameter configuration.

After choosing language, navigate through setup parameters individually. Alternatively, use a pre-defined quick menu or a SmartStart guide for application specific setup.

The LCP can be detached and used to copy settings to other VLT® HVAC Drives in the system. It can also be mounted remotely on a control panel fascia. This enables the user to take full advantage of the LCP, eliminating the need for additional switches and instrumentation.

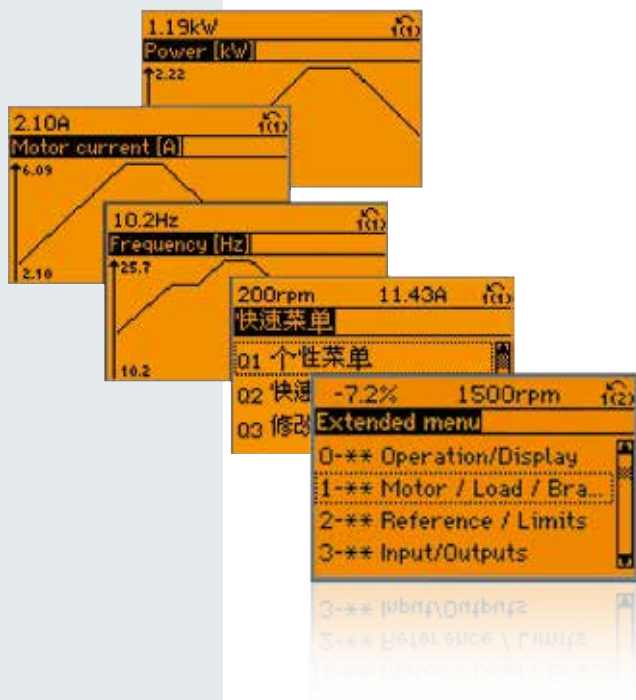



Save commissioning time with SmartStart

SmartStart is a time-saving drive setup wizard that guides you through a series of easy steps to configure your drive. The wizard can be accessed with the drive's graphical control panel at the first power up of the drive or after a factory reset.

Uses HVAC language

Using HVAC language, SmartStart asks you to enter motor information and the application profile. The drive then calculates the optimal values to ensure reliable and energy efficient operation. SmartStart supports set-up for induction, SynRM and PM motors. This enables fast commissioning of all these motor types.

Intelligent optimization

SmartStart also asks if you want to apply the intelligent VLT features Automatic Motor Adaptation and Automatic Energy Optimization, enabling even more efficient motor control.

SmartStart is deactivated when the drive is programmed via fieldbus and after a timeout.

NOTE: SmartStart is only accessible with the graphical control panel.

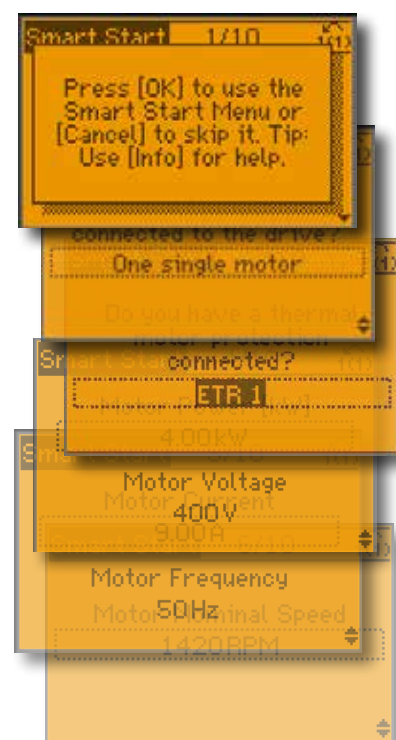



Intelligent AHU functions

The ability to handle logical rules and inputs from sensors, real-time functionality, and time-related actions enables the VLT® HVAC Drive to control a wide range of functions:

- *Weekend and working day operations*
- *Cascaded P-PI for temperature control*
- *Multi-zone "3" control*
- *Flow balancing between fresh and outlet air*
- *Belt monitoring*

Dedicated fan features

The VLT® HVAC Drive offers a wide range of built-in and expandable functions that increase comfort and safety while reducing energy consumption.

Velocity to flow conversion

The VLT® HVAC Drive is able to convert velocity pressure sensor values into flow values. This provides operators with the opportunity to set the drive up to provide a fixed flow or fixed differential flow. Regardless of method, the advantages are the same, as energy consumption is optimized while improving comfort. An added benefit is that this built-in setting eliminates the need for a flow sensor.

Fire override mode

This safety feature prevents the drive from stopping to protect itself. Instead it will continue vital fan operation regardless of control signals, warnings or alarms.

Extended BMS capacity

Easy integration into building management systems (BMS) provides managers with detailed information about the current state of the infrastructure in the building. By integrating the drive into the building management network, all the I/O points in the drive are available as remote I/O to extend the capacity of the BMS.

For example: by installing room temperature sensors (PT 100/PT 1000) and monitoring them with the VLT® Sensor Input Card, the motor is protected from overheating in the bearings and windings. Monitoring of sensor temperature is either visible as a readout on the display or via fieldbus.

Resonance monitoring

Avoid unwanted noise by setting the drive to avoid the frequency bands that cause fans to create resonances. Not only does this increase comfort, it also reduces wear on the equipment.

Stairwell pressurization

If there is a fire, the VLT® HVAC Drive will continue to control the motor, even beyond its standard shutoff parameters. By maintaining a higher level of air in the stairwells than in other parts of the building, fire escapes remain smoke free.

Smart logic reduces costs

The drive's built-in Smart Logic Controller and four auto-tuning PID controllers can control air handling functions with fans, valves and dampers. This reduces DDC tasks in the building management system and frees valuable data points for other use.



Mains switch

The mains switch is a safety feature that makes it possible to cut off the drive from the mains supply. As a result maintenance and cleaning are easy and safe. The mains switch option also reduces assembly costs.



Dedicated pump features

The VLT® HVAC Drive is developed in close cooperation with OEMs, contractors, and manufacturers around the world. Each drive contains a wide range of built-in, dedicated features which save energy in pump applications.

Embedded pump controller

The Pump Cascade Controller distributes operation hours evenly across all pumps. Wear and tear on individual pumps is therefore reduced to a minimum, extending their lifetime expectancy and reliability considerably.

Vital water supply

If a pipe leaks or breaks, the VLT® HVAC Drive can reduce the motor speed to prevent overload, while continuing to supply water at a lower speed.

Sleep mode

In situations with low or now flow, the drive enters sleep mode to conserve energy. When the pressure falls below the pre-defined setpoint, the drive starts automatically. Compared to continuous operation this method reduces energy costs and equipment wear and tear, extending the lifetime of the application.

1. Dry Pump Protection and End of Curve

If the pump runs without creating the desired pressure, the drive sets off an alarm or performs another pre-programmed action. This happens for example when a well runs dry or a pipe leaks.

2. Auto tuning of PI controllers

Auto tuning enables the drive to monitor how the system reacts to corrections made by the drive constantly. The drive learns from it and calculates the P and I values, so precise and stable operation is restored quickly.

3. Flow compensation

A pressure sensor mounted close to the fan or pump provides a reference point that enables pressure to be kept constant at

the discharge end of the system. The drive constantly adjusts the pressure reference to follow the system curve. This method both saves energy and reduces installation costs.

4. No/low flow

During operation, a pump normally consumes more power the faster it runs. In situations where the pump runs fast, but is not fully loaded, and does not consume adequate power, the drive compensates accordingly. This is a particular advantage when water circulation stops, the pump runs dry or when pipes leak.

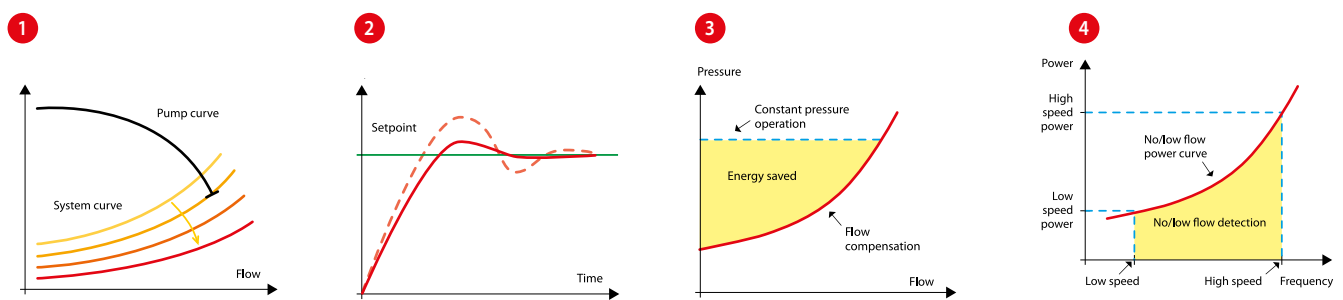

Optimize system performance with EC+

Danfoss EC+ concept gives manufacturers of ventilation units the freedom to select their preferred motor from any supplier and control it with a VLT® drive.

Optimize PM motor performance

Danfoss has refined its VVC+ algorithm and optimized it for permanent magnet and SynRM motors. This improvement makes it possible for owners to benefit from the high motor efficiency of EC technology. After entering the relevant motor data, the drive automatically optimizes the performance of the application.

Free choice of technology

VLT® drives are equally efficient at controlling PM, SynRM, and induction motors.

By providing vendors with the freedom to select the optimum combination of drive and motor, it is possible to offer the best possible system efficiency. This is a clear advantage compared to integrated systems, where it often is not possible to optimize the individual components.

Easy maintenance

Component replacement as a result of wear and tear is not always possible without installing a complete new, integrated system. The EC+ concept answers this challenge by making service and maintenance easier, as only the affected component needs to be repaired/replaced in the event of malfunction.

Downtime is therefore reduced, and so are maintenance costs. These savings are the result of the fact that the EC+ concept is based on standardized components. All units can be shipped at short notice and installed with little effort.

Highest efficiency with EC+

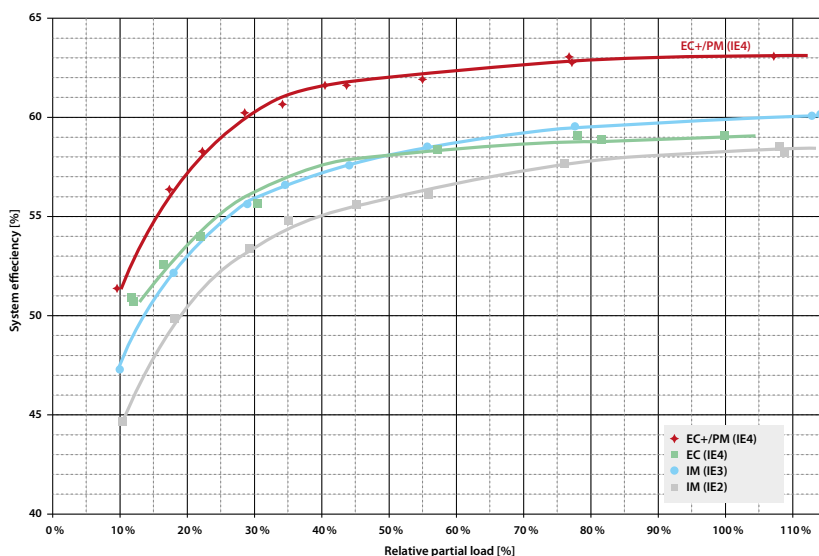

Tests at the Institute of Air Handling and Refrigeration (ILK) in Dresden have shown that the EC+ concept lowers the losses in ventilator systems by up to 10%, compared to conventional EC technology. This is the result of 3-5% higher system efficiency, depending on the nominal power size and the partial load.

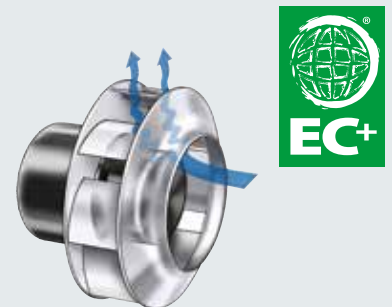

EC motor with electronics built into the fan impeller impacts the airflow through the impeller.

EC motor + integrated electronics + fan

$\eta_{\text{Drive}} = 89\% \mid \eta_{\text{Fan}} = 66\% \mid \eta_{\text{System}} = 59\%$

Values related to ILK report

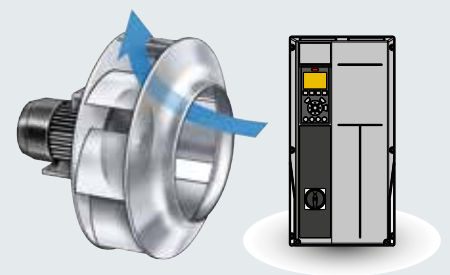

Plugfan with optimal and efficient airflow through the fan impeller, in combination with AC drive and high-efficiency foot-mounted permanent magnet motor.

PM/EC motor + VSD + direct drive fan

$\eta_{\text{Drive}} = 89\% \mid \eta_{\text{Fan}} = 71\% \mid \eta_{\text{System}} = 63\%$

Values related to ILK report

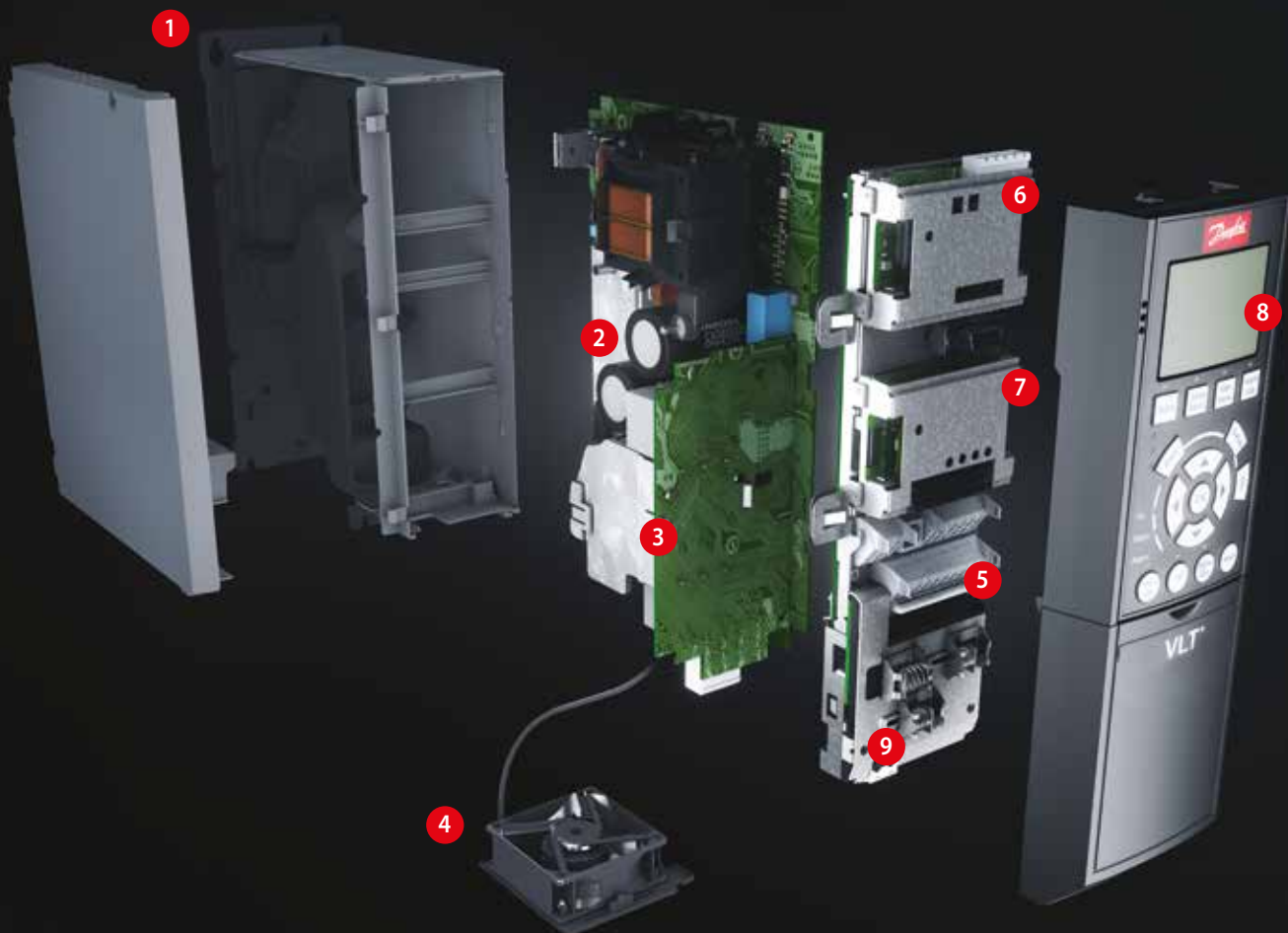

Modular simplicity

Delivered fully assembled and tested to meet your specific requirements

1. Enclosure

The drive meets requirements for enclosure class IP20/Chassis. IP21/Type 1, IP54/Type 12, IP55/Type 12 or IP66/Type 4X.

2. EMC and Network effects

All versions of VLT® HVAC Drive comply as standard with EMC limits B, A1 or A2 according to the EN 55011 norm and IEC61800-3 Category C1, C2 and C3. The standard integrated DC coils ensure low harmonic load on the network according to EN 61000-3-12 and increase the lifetime of the DC link capacitors.

3. Protective coating

The electronic components are, as standard, coated as per IEC 60721-3-3, class 3C2. For harsh and aggressive environments, coating as per IEC 60721-3-3, class 3C3 is available.

4. Removable fan

Like most of the elements, the fan can be quickly removed and remounted for easy cleaning.

5. Control terminals

Double-stack, spring-loaded cage clamps enhance reliability and facilitate easy commissioning and service.

6. Fieldbus option

Obtain access to additional fieldbus protocols via options. For a complete list, see page 34.

7. I/O extensions

A wide range of I/O options are available either factory-mounted or as retrofit.

8. Display option

The removable Local Control Panel is available with a variety of language packs: East European, West European, Asian and North American.

English and German are available in all drives.

Alternatively the drive can be commissioned via the built-in USB/RS485 connection or a fieldbus from with VLT® Motion Control Tool MCT 10 setup software.

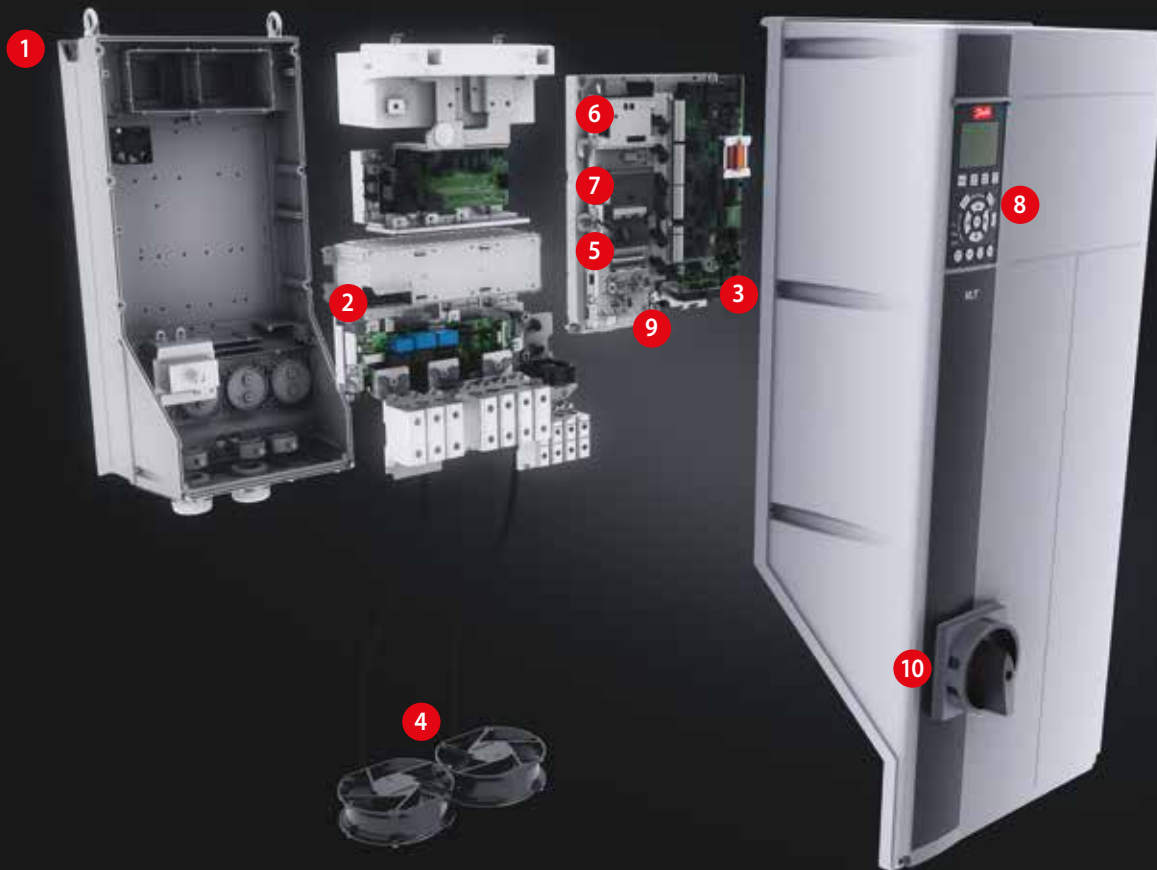

9. 24 V external power supply

The external 24 V supply keeps the VLT® HVAC Drive logic “alive” when the AC mains is removed.

10. Mains switch

This switch interrupts the mains supply and has a free useable auxiliary contact.

Safety

The VLT® HVAC Drive can optionally be delivered with the Safe Torque Off (Safe Stop) functionality suitable for category 3, performance level d according to EN 13849-1 and SIL 2 according to IEC 62061/IEC 61508. This feature prevents the drive from unintended startup.

Built-in Smart Logic Controller

The Smart Logic Controller is a clever way to add customer-specific functionality to the drive and increase the opportunities for the drive, motor and application working together.

The controller monitors a specified event. When an event occurs, the controller performs a pre-defined action and then starts monitoring for the next pre-defined event. 20 steps of events and resulting actions are available before returning to the first set.

Logic functions can be selected; most of them run independently of the sequence control. This enables drives to monitor variables or signal defined events in an easy and flexible way independently of the motor control.

The big picture

An investment that pays

Increase application performance and streamline processes with energy efficient, adaptive motor control. Combine reliable, high performing solutions from a single supplier to reduce the lifetime costs of your applications.

Minimize energy costs

As energy becomes increasingly expensive, variable speed control of electrical motors has proven to be one of the most effective cost-reducing measures available.

For example, by reducing the average speed of the motor from 100% to 80% in pumps or fans, 50% energy is saved. Reducing the average speed by 50% increases the savings to 80%.

Reduce total cost of ownership

Seen over its lifetime, the initial cost of a drive only amounts to 10% of the total cost of ownership; the remaining 90% covers energy consumption, service and maintenance.

During setup and operation, respectively, Automatic Motor Adaptation (AMA) and Automatic Energy Optimization (AEO) ensure that the drive is perfectly adapted to the connected motor, and changing loads.

Once in operation, VLT® drives serve reliably for their entire lifetime. Only requiring minimal maintenance, the VLT® HVAC Drive provides a fast return on investment and ultimately a competitive cost of ownership.

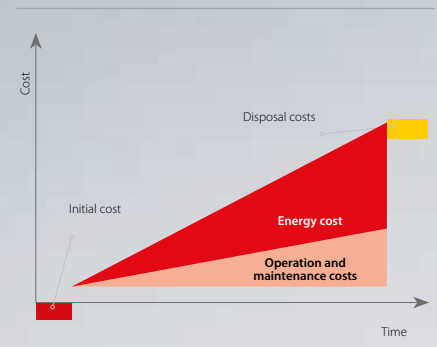

Automatic Energy Optimization ensures that the motor voltage adapts automatically to changing loads. This provides an efficiency boost of up to 5-15%, reducing the cost of ownership substantially.

On the following pages we help you select the optimal VLT® for applications from 1.1 and 400 kW. For larger drives, please consult the selection guide for VLT® High Power Drives.



Cut your installation costs the easy way – with integrated energy metering

Obtain greener projects

With the built-in energy meter in Danfoss VLT® HVAC Drive FC 102 you can read out your energy consumption with a tolerance below +/- 7%. This accuracy is sufficient to allow you to achieve greener projects which run more smoothly, by monitoring and tracking the energy consumption in your HVAC systems.

Reduce complexity

Since the energy meter is integrated into the VLT® HVAC Drive, you achieve a huge complexity reduction. There is no need to purchase, install, validate and maintain a separate energy meter for each installed AC drive when you want to monitor your energy consumption.

What can you save?

Using VLT® HVAC Drive with built-in energy metering, there is no need to invest in a separate energy meter. Typically the component reduction from drive plus energy meter to drive with integrated energy meter reduces capital investment by 25%.

Avoid separate meter validation

Where a remote meter reading system is used to record the pulse meter reading, in some regions this must be validated in accordance with local non-utility meter validation requirements, to ensure it is recording the measured consumption correctly. One example of such a system is the National Australian Built Environment Rating System (NABERS) in Australia.

When using the VLT® HVAC Drive with integrated energy meter, this separate validation process is usually not required, saving time and cost. These savings are achievable because in normal practice, the BMS installation maps the energy consumption data from the AC drive. The validation of the energy meter is therefore already a part of the process of BMS commissioning.

What is NABERS?

The National Australian Built Environment Rating System (NABERS) is a performance-based rating system for buildings in Australia. Put simply, NABERS measures the energy efficiency, water usage, waste management and indoor environment quality of a building or tenancy and its impact on the environment.

In Australia, if you own, manage or occupy a building, a NABERS rating can provide you with a simple indication of how well you are managing these environmental impacts compared to similar buildings.

Find more information at www.nabers.gov.au.

The measurement accuracy of the VLT® HVAC Drive with integrated energy meter is well within the required +/-10% tolerance required by NABERS. The VLT® HVAC Drive complies fully with NABERS requirements.

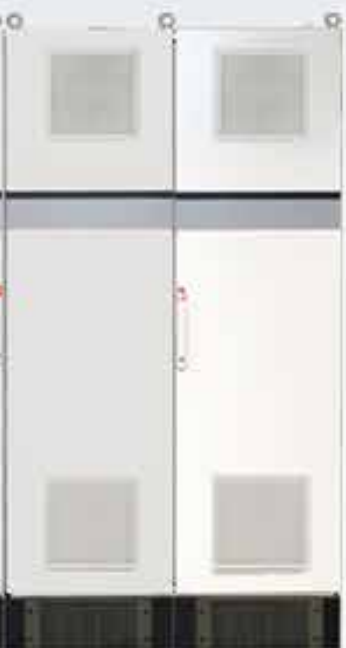

Specifications

Basic unit without extensions

Main supply (L1, L2, L3)	
Supply voltage	200 – 240 V ±10%
Supply voltage	380 – 480 V ±10%
Supply voltage	525 – 600 V ±10%
Supply voltage	525 – 690 V ±10%
Supply frequency	50/60 Hz
Displacement power factor (cos φ)	> 0.98 near unity
Switching on input supply L1, L2, L3	1–2 times/min.
Harmonic disturbance	Meets EN 61000-3-12

Output data (U, V, W)	
Output voltage	0 – 100% of supply voltage
Output frequency	0–590 Hz
Switching on output	Unlimited
Ramp times	1 – 3600 sec.

Digital inputs	
Programmable digital inputs	6*
Changeable to digital output	2 (terminal 27, 29)
Logic	PNP or NPN
Voltage level	0 – 24 V DC
Maximum voltage on input	28 V DC
Input resistance, Ri	Approx. 4 kΩ
Scan interval	5 ms

* 2 can be used as digital outputs

Analog inputs	
Analog inputs	2
Modes	Voltage or current
Voltage level	0 to +10 V (scaleable)
Current level	0/4 to 20 mA (scaleable)
Accuracy of analog inputs	Max. error: 0.5% of full scale

Pulse inputs	
Programmable pulse inputs	2*
Voltage level	0 – 24 V DC (PNP positive logic)
Pulse input accuracy (0.1 – 1 kHz)	Max. error: 0.1% of full scale

* Utilize some of the digital inputs

Digital outputs	
Programmable digital/pulse outputs	2
Voltage level at digital/frequency output	0 – 24 V DC
Max. output current (sink or source)	40 mA
Maximum output frequency at frequency output	0 to 32 kHz
Accuracy on frequency output	Max. error: 0.1% of full scale

Analog output	
Programmable analog outputs	1
Current range at analog output	0/4 – 20 mA
Max. load to common at analog output (clamp 39)	500 Ω
Accuracy on analog output	Max. error: 1% of full scale

Control card	
USB interface	1.1 (Full Speed)
USB plug	Type "B"
RS485 interface	Up to 115 kBaud
Max. load (10 V)	15 mA
Max. load (24 V)	200 mA

Relay output	
Programmable relay outputs	2
Max. terminal load (AC) on 1-3 (break), 1-2 (make), 4-6 (break) power card	240 V AC, 2 A
Max. terminal load (AC) on 4-5 (make) power card	400 V AC, 2 A
Min. terminal load on 1-3 (break), 1-2 (make), 4-6 (break), 4-5 (make) power card	24 V DC 10 mA, 24 V AC 20 mA

Surroundings/external	
Enclosure	IP: 00/20/21/54/55/66 UL Type: Chassis/1/12/3R/4X Outdoor
Vibration test	1.0 g (D enclosures: 0.7 g)
Max. relative humidity	5% – 95% (IEC 721-3-3; Class 3K3 (non-condensing) during operation)
Ambient temperature	Max. 50° C w/o derating
Galvanic isolation of all	I/O supplies according to PELV
Aggressive environment	Designed for coated/standard 3C3/3C2 (IEC 60721-3-3)

Fieldbus communication	
Standard built-in: FC Protocol N2 Metasys FLN Apogee Modbus RTU BACnet (embedded)	Optional: VLT® PROFIBUS DP V1 MCA 101 VLT® DeviceNet MCA 104 VLT® LonWorks MCA 108 VLT® BACnet MCA 109 VLT® PROFINET MCA 120 VLT® EtherNet/IP MCA 121 VLT® Modbus TCP MCA 122 VLT® BACnet/IP MCA 125

Protection mode for longest possible up-time	
– Electronic thermal motor protection against overload	
– Temperature monitoring of the heatsink ensures that the drive trips if the temperature reaches 95° C ± 5° C	
– The drive is protected against short-circuits on motor terminals U, V, W	
– The drive is protected against earth faults on motor terminals U, V, W	
– Protection against mains phase loss	



Connection examples

The numbers represent the terminals on the drive

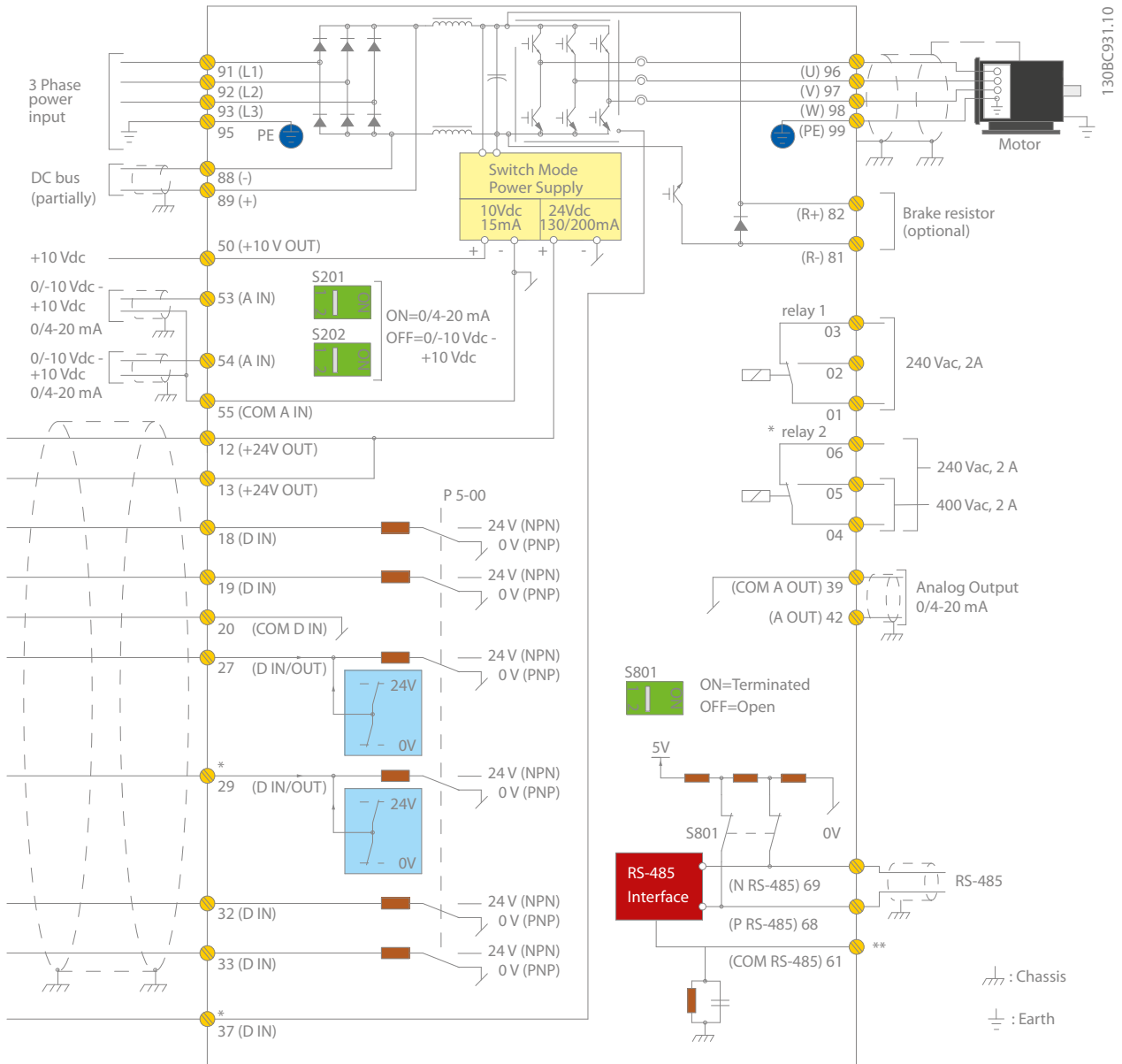

This diagram shows a typical installation of the VLT® HVAC Drive. Power is connected to the terminals 91 (L1), 92 (L2) and 93 (L3) and the motor is connected to 96 (U), 97 (V) and 98 (W).

Terminals 88 and 89 are used for load sharing between drives.

Analog inputs can be connected to the 53 (V or mA), and for 54 (V or mA) terminals.

These inputs can be set up as either reference, feedback or thermistor inputs.

There are 6 digital inputs to be connected to terminals 18, 19, 27, 29, 32, and 33. Two digital input/output terminals (27 and 29) can be set up as digital outputs to show an actual status or warning. The terminal 42 analogue output can show process values such as $0 - I_{max}$.

On the 68 (P+) and 69 (N-) terminals' RS 485 interface, the drive can be controlled and monitored via serial communication.

Diagram showing all electrical terminals without options.

*A = analog, D = digital
Terminal 37 is used for Safe Stop. For instructions on Safe Stop installation please refer to the section Safe Stop Installation of the Design Guide.*

**Terminal 37 is optional.
** Do not connect cable screen*

VLT® HVAC Drive 200-240 V AC

Enclosure	IP20 (IP21*)/Chassis (Type 1)	A2			A3	
	IP55, IP66/Type 4X	A4 + A5			A5	
		P1K1	P1K5	P2K2	P3K0	P3K7
Typical shaft output	[kW]	1.1	1.5	2.2	3	3.7
Typical shaft output at 208 V	[HP]	1.5	2.0	2.9	4.0	4.9
Output current						
Continuous (3 x 200 – 240 V)	[A]	6.6	7.5	10.6	12.5	16.7
Intermittent (3 x 200 – 240 V)	[A]	7.3	8.3	11.7	13.8	18.4
Output power						
Continuous (208 V AC)	[kVA]	2.38	2.70	3.82	4.50	6.00
Rated input current						
Continuous (3 x 200 – 240 V)	[A]	5.9	6.8	9.5	11.3	15.0
Intermittent (3 x 200 – 240 V)	[A]	6.5	7.5	10.5	12.4	16.5
Estimated power loss at rated max. load	[W]	63	82	116	155	185
Efficiency		0.96				
Max. cable size Mains, motor, brake	[mm ²] ([AWG])	4 (12)				
Max. pre-fuses	[A]	20			32	
Weight						
IP20	[kg]	4.9			6.6	
IP21	[kg]	5.5			7.5	
IP55, IP66	[kg]	9.7 (A4)/13.5 (A2 + A5)			13.5	

Enclosure	IP20 (IP21*)/Chassis (Type 1)	B3			B4		C3		C4		
	IP21/Type 1, IP55, IP66/Type 4X	B1			B2	C1		C2			
		P5K5	P7K5	P11K	P15K	P18K	P22K	P30K	P37K	P45K	
Typical shaft output	[kW]	5.5	7.5	11	15	18.5	22	30	37	45	
Typical shaft output at 208 V	[HP]	7.5	10	15	20	25	30	40	50	60	
Output current											
Continuous (3 x 200 – 240 V)	[A]	24.2	30.8	46.2	59.4	74.8	88	115	143	170	
Intermittent (3 x 200 – 240 V)	[A]	26.6	33.9	50.8	65.3	82.3	96.8	127	157	187	
Output power											
Continuous (208 V AC)	[kVA]	8.7	11.1	16.6	21.4	26.9	31.7	41.4	51.5	61.2	
Rated input current											
Continuous (3 x 200 – 240 V)	[A]	22	28	42	54	68	80	104	130	154	
Intermittent (3 x 200 – 240 V)	[A]	24.2	30.8	46.2	59.4	74.8	88	114	143	169	
Estimated power loss at rated max. load	[W]	269	310	447	602	737	845	1140	1353	1636	
Efficiency		0.96					0.97				
Max. cable size Mains, motor, brake	[mm ²] ([AWG])	10 (7)			35 (2)	50 (1) (B4 = 35 (2))		150 (300 MCM)	150 (300 MCM)		
Max. cable size mains With mains disconnect switch included	[mm ²] ([AWG])	16 (6)			35 (2)	50, 35, 35 (1, 2, 2)		95, 70, 70 (3/0, 2/0, 2/0)	185, 150, 120 (350 MCM, 300 MCM, 4/0)		
Max. pre-fuses	[A]	63			80	125	160	200	250		
Weight											
IP20	[kg]	12			23.5		35		50		
IP21, IP55, IP66	[kg]	23			27		45		65		

* (A2, A3, B3, B4, C3 and C4 may be converted to IP21/Type 1 using a conversion kit.
(Please see also items mechanical mounting in Operating Instructions and IP21/Type 1 enclosure kit in the Design Guide.)

VLT® HVAC Drive 380 – 480 V AC

Enclosure	IP20 (IP21*)/Chassis (Type 1)		A2					A3		
	IP55, IP66 /Type 4X		A4 + A5					A5		
			P1K1	P1K5	P2K2	P3K0	P4K0	P5K5	P7K5	
Typical shaft output	[kW]		1.1	1.5	2.2	3	4	5.5	7.5	
Typical shaft output at 460 V	[HP]		1.5	2.0	2.9	4.0	5.0	7.5	10	
Output current										
Continuous (3 x 380 – 440 V)	[A]		3	4.1	5.6	7.2	10	13	16	
Intermittent (3 x 380 – 440 V)	[A]		3.3	4.5	6.2	7.9	11	14.3	17.6	
Continuous (3 x 441 – 480 V)	[A]		2.7	3.4	4.8	6.3	8.2	11	14.5	
Intermittent (3 x 441 – 480 V)	[A]		3.0	3.7	5.3	6.9	9.0	12.1	15.4	
Output power										
Continuous (400 V AC)	[kVA]		2.1	2.8	3.9	5.0	6.9	9.0	11.0	
Continuous (460 V AC)	[kVA]		2.4	2.7	3.8	5.0	6.5	8.8	11.6	
Rated input current										
Continuous (3 x 380 – 440 V)	[A]		2.7	3.7	5.0	6.5	9.0	11.7	14.4	
Intermittent (3 x 380 – 440 V)	[A]		3.0	4.1	5.5	7.2	9.9	12.9	15.8	
Continuous (3 x 441 – 480 V)	[A]		2.7	3.1	4.3	5.7	7.4	9.9	13.0	
Intermittent (3 x 441 – 480 V)	[A]		3.0	3.4	4.7	6.3	8.1	10.9	14.3	
Estimated power loss at rated max. load	[W]		58	62	88	116	124	187	255	
Efficiency			0.96		0.97					
Max. cable size (Mains, motor, brake)	[mm ²] ([AWG])		4 (12)							
Max. pre-fuses	[A]		10		20			32		
Weight										
IP20	[kg]		4.8		4.9			6.6		
IP55, IP66	[kg]		9.7 (A4)/13.5 (A2 + A5)							14.2

Enclosure	IP20 (IP21*)/Chassis (Type 1)		B3			B4			C3		C4		
	IP21/Type 1, IP55, IP66/Type 4X		B1			B2		C1		C2			
			P11K	P15K	P18K	P22K	P30K	P37K	P45K	P55K	P75K	P90K	
Typical shaft output	[kW]		11	15	18.5	22	30	37	45	55	75	90	
Typical shaft output at 460 V	[HP]		15	20	25	30	40	50	60	75	100	125	
Output current													
Continuous (3 x 380 – 440 V)	[A]		24	32	37.5	44	61	73	90	106	147	177	
Intermittent (3 x 380 – 440 V)	[A]		26.4	35.2	41.3	48.4	67.1	80.3	99	117	162	195	
Continuous (3 x 441 – 480 V)	[A]		21	27	34	40	52	65	80	105	130	160	
Intermittent (3 x 441 – 480 V)	[A]		23.1	29.7	37.4	44	61.6	71.5	88	116	143	176	
Output power													
Continuous (400 V AC)	[kVA]		16.6	22.2	26	30.5	42.3	50.6	62.4	73.4	102	123	
Continuous (460 V AC)	[kVA]		16.7	21.5	27.1	31.9	41.4	51.8	63.7	83.7	104	128	
Rated input current													
Continuous (3 x 380 – 440 V)	[A]		22	29	34	40	55	66	82	96	133	161	
Intermittent (3 x 380 – 440 V)	[A]		24.2	31.9	37.4	44	60.5	72.6	90.2	106	146	177	
Continuous (3 x 441 – 480 V)	[A]		19	25	31	36	47	59	73	95	118	145	
Intermittent (3 x 441 – 480 V)	[A]		20.9	27.5	34.1	39.6	51.7	64.9	80.3	105	130	160	
Estimated power loss at rated max. load	[W]		278	392	465	525	698	739	843	1083	1384	1474	
Efficiency			0.98									0.99	
Max. cable size Mains, motor, brake	[mm ²] ([AWG])		10 (8)			35 (2)		50 (1) (B4 = 35 (2))		95 (4/0)		95 (4/0)	
Max. cable size mains With mains disconnect switch included	[mm ²] ([AWG])		16, 10, 10 (6, 8, 8)						50, 35, 35 (1, 2, 2)		95, 70, 70 (3/0, 2/0, 2/0)		185, 150, 120 (350 MCM, 300 MCM, 4/0)
Max. pre-fuses	[A]		63	63	63	63	80	100	125	160	250	250	
Weight													
IP20	[kg]		12	12	12	23.5	23.5	23.5	35	35	50	50	
IP21, IP55, IP66	[kg]		23	23	23	27	27	45	45	45	65	65	

* (A2, A3, B3, B4, C3 and C4 may be converted to IP21 using a conversion kit. Please contact Danfoss.
(Please see also items Mechanical mounting in Operating Instructions and IP21/ Type 1 Enclosure kit in the Design Guide.)
1) With brake and load sharing 95 (4/0)

VLT® HVAC Drive 3 x 380 – 480 V AC

Enclosure	IP20		D3h			D4h		
	IP21, IP55		D1h + D5h + D6h			D2h + D7h + D8h		
			N110	N132	N160	N200	N250	N315
Typical shaft output (400 V)	[kW]		110	132	160	200	250	315
Typical shaft output (460 V)	[HP]		150	200	250	300	350	450
Typical shaft output (480 V)	[kW]		132	160	200	250	315	355
Output current								
Continuous (3 x 380 – 440 V)	[A]		212	260	315	395	480	588
Intermittent (3 x 380 – 440 V)	[A]		233	286	347	435	528	647
Continuous (3 x 441 – 480 V)	[A]		190	240	302	361	443	535
Intermittent (3 x 441 – 480 V)	[A]		209	264	332	397	487	588
Output power								
Continuous (400 V)	[kVA]		147	180	218	274	333	407
Continuous (460 V)	[kVA]		151	191	241	288	353	426
Rated input current								
Continuous (400 V)	[A]		204	251	304	381	463	567
Intermittent (460/500 V)	[A]		183	231	291	348	427	516
Estimated power loss at rated max. load	[W]		2555	2949	3764	4109	5129	6663
Efficiency			0.98					
Max. cable size Mains, motor, brake and loadsharing	[mm ²] ([AWG])		2 x 95 (2 x 3/0)			2 x 185 (2 x 350 mcm)		
Max. external input (mains) fuses	[A]		315	350	400	550	630	800
Weight								
IP20, IP21, IP54	[kg]		62 (D1h + D3h) 166 (D5h), 129 (D6h)			125 (D2h + D4h) 200 (D7h), 225 (D8h)		

VLT® HVAC Drive 525 – 600 V AC

Enclosure																			
IP20 Chassis		A3				A3				B3			B4			C3		C4	
IP21/Type 1		A5								B1			B2			C1		C2	
IP55, IP66/Type 4X		P1K1	P1K5	P2K2	P3K0	P4K0	P5K5	P7K5	P11K	P15K	P18K	P22K	P30K	P37K	P45K	P55K	P75K	P90K	
Typical shaft output	[kW]	1.1	1.5	2.2	3	4	5.5	7.5	11	15	18.5	22	30	37	45	55	75	90	
Output current																			
Continuous (3 x 525 – 550 V)	[A]	2.6	2.9	4.1	5.2	6.4	9.5	11.5	19	23	28	36	43	54	65	87	105	137	
Intermittent (3 x 525 – 550 V)	[A]	2.9	3.2	4.5	5.7	7.0	10.5	12.7	21	25	31	40	47	59	72	96	116	151	
Continuous (3 x 525 – 600 V)	[A]	2.4	2.7	3.9	4.9	6.1	9.0	11.0	18	22	27	34	41	52	62	83	100	131	
Intermittent (3 x 525 – 600 V)	[A]	2.6	3.0	4.3	5.4	6.7	9.9	12.1	20	24	30	37	45	57	68	91	110	144	
Output power																			
Continuous (525 V AC)	[kVA]	2.5	2.8	3.9	5.0	6.1	9.0	11.0	18.1	21.9	26.7	34.3	41	51.4	61.9	82.9	100	130.5	
Continuous (575 V AC)	[kVA]	2.4	2.7	3.9	4.9	6.1	9.0	11.0	17.9	21.9	26.9	33.9	40.8	51.8	61.7	82.7	99.6	130.5	
Rated input current																			
Continuous (3 x 525-600 V)	[A]	2.4	2.7	4.1	5.2	5.8	8.6	10.4	17.2	20.9	25.4	32.7	39	49	59	78.9	95.3	124.3	
Intermittent (3 x 525 – 600 V)	[A]	2.7	3.0	4.5	5.7	6.4	9.5	11.5	19	23	28	36	43	54	65	87	105	137	
Estimated power loss at rated max. load	[W]	50	65	92	122	145	195	261	300	400	475	525	700	750	850	1100	1400	1500	
Efficiency		0.97	0.97	0.97	0.97	0.97	0.97	0.97	0.98	0.98	0.98	0.98	0.98	0.98	0.98	0.98	0.98	0.98	
Max. cable size IP20, mains, motor, brake	[mm ²] ([AWG])	4 (12)						10 (8)			35 (2)			50 (1/0)		95 (4/0)	120 (250 MCM)		
Max. cable size IP21, IP55, IP66, mains, motor, brake	[mm ²] ([AWG])	4 (12)						10 (8)			35, 25, 25 (2, 4, 4)			50 (1)		150 (300 MCM)			
Max. cable size mains With mains disconnect switch included	[mm ²] ([AWG])	4 (12)						16, 10, 10 (8, 8, 8)			50, 35, 35 (1, 2, 2)			95, 70, 70 (3/0, 2/0, 2/0)		185, 150, 120 (350 MCM, 300 MCM, 4/0)			
Max. pre-fuses	[A]	10	10	20	20	20	32	32	63	63	63	63	80	100	125	160	250	250	
Weight																			
IP20	[kg]	6.5	6.5	6.5	6.5	6.5	6.6	6.6	12	12	12	23.5	23.5	23.5	35	35	50	50	
IP21, IP55, IP66	[kg]	13.5	13.5	13.5	13.5	13.5	14.2	14.2	23	23	23	27	27	27	45	45	65	65	

VLT® HVAC Drive 3 x 525-690 V AC

Enclosure	IP20	A3							B4					C3			D3h		
		IP21/IP55								B2					C2				
		P1K1	P1K5	P2K2	P3K0	P4K0	P5K5	P7K5	P11K	P15K	P18K5	P22K	P30K	P37K	P45K	P55K	P75K	P90K	
Typical shaft output (690 V)	[kW]	1.1	1.5	2.2	3	4	5.5	7.5	11	15	18.5	22	30	37	45	55	75	90	
Output current (High overload 110% for 1 min.)																			
Continuous (3 x 525-550 V)	[A]	2.1	2.7	3.9	4.9	6.1	9	11	14	19	23	28	36	43	54	65	87	105	
Intermittent (3 x 525-550 V)	[A]	3.4	4.3	6.2	7.8	9.8	14.4	17.6	22.4	20.9	25.3	30.8	39.6	47.3	59.4	71.5	95.7	115.5	
Continuous kVA (3 x 551-690 V)	[A]	1.6	2.2	3.2	4.5	5.5	7.5	10	13	18	22	27	34	41	52	62	83	100	
Intermittent kVA (3 x 551-690 V)	[A]	2.6	3.5	5.1	7.2	8.8	12	16	20.8	19.8	24.2	29.7	37.4	45.1	57.2	68.2	91.3	110	
Output power																			
Continuous (550 V) (A3 525 V)	[kVA]	1.9	2.5	3.5	4.5	5.5	8.2	10	13.3	18.1	21.9	26.7	34.3	41.0	51.4	61.9	82.9	100	
Continuous (690 V)	[kVA]	1.9	2.6	3.8	5.4	6.6	9	12	15.5	21.5	26.3	32.3	40.6	49.0	62.1	74.1	99.2	119.5	
Rated input current																			
Continuous (3 x 525-550 V)	[A]	1.9	2.4	3.5	4.4	5.5	8	10	15	19.5	24	29	36	49	59	71	87	99	
Intermittent (3 x 525-550 V)	[A]	3	3.9	5.6	7.1	8.8	13	16	23.2	21.5	26.4	31.9	39.6	53.9	64.9	78.1	95.7	108.9	
Continuous kVA (3 x 551-690 V)	[A]	1.4	2	2.9	4	4.9	6.7	9	14.5	19.5	24	29	36	48	58	70	86	94.3	
Intermittent kVA (3 x 551-690 V)	[A]	2.3	3.2	4.6	6.5	7.9	10.8	14.4	23.2	21.5	26.4	31.9	39.6	52.8	63.8	77	94.6	112.7	
Estimated power loss at rated maximum load	[W]	44	60	88	120	160	220	300	150	220	300	370	440	740	900	1100	1500	1800	
Efficiency					0.96								0.98						
Max. cable cross section Mains, motor, brake and load sharing	[mm ²] ([AWG])				4 (12)								35 (2)						
Max. external input (mains) fuses	[A]				-					63			80	100	125	160		-	
Weight																			
IP20	[kg]				6.6					21.5 (B4)					35 (C3)		62 (D3h)		
IP21, IP55	[kg]				-					27 (B2)					65 (C2) – 62 (D3h)				

Enclosure	IP20	D3h					D4h			
		IP21, IP55	D1h + D5h + D6h				D2h + D7h + D8h			
		N75K	N90K	N110	N132	N160	N200	N250	N315	N400
Typical shaft output (525 V)	[kW]	55	75	90	110	132	160	200	250	315
Typical shaft output (575 V)	[HP]	75	100	125	150	200	250	300	350	400
Typical shaft output (690 V)	[kW]	75	90	110	132	160	200	250	315	400
Output current										
Continuous (550 V)	[A]	90	113	137	162	201	253	303	360	418
Intermittent (550 V)	[A]	99	124	151	178	221	278	333	396	460
Continuous (575/690 V)	[A]	86	108	131	155	192	242	290	344	400
Intermittent (575/690 V)	[A]	95	119	144	171	211	266	319	378	440
Output power										
Continuous (525 V)	[kVA]	86	108	131	154	191	241	289	343	398
Continuous (575 V)	[kVA]	86	108	130	154	191	241	289	343	398
Continuous (690 V)	[kVA]	103	129	157	185	229	289	347	411	478
Rated input current										
Continuous (550 V)	[A]	89	110	130	158	198	245	299	355	408
Continuous (575 V)	[A]	85	106	124	151	189	234	286	339	390
Continuous (690 V)	[A]	87	109	128	155	197	240	296	352	400
Estimated power loss at 525/575 V	[W]	1162	1428	1739	2099	2646	3071	3719	4460	5023
Estimated power loss at 690 V	[W]	1204	1477	1796	2165	2738	3172	3848	4610	5150
Efficiency						0.98				
Max. cable size Mains, motor, brake and loadsharing	[mm ²] ([AWG])			2 x 95 (2 x 3/0)			2 x 185 (2 x 350 mcm)			
Max. external input (mains) fuses	[A]	160	315			350		400	500	550
Weight										
IP20, IP21, IP54	[kg]		62 (D1h + D3h) 166 (D5h), 129 (D6h)				125 (D2h + D4h) 200 (D7h), 225 (D8h)			

Dimensions and air flow

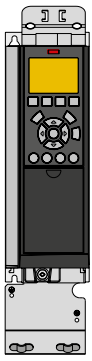

A2 IP20

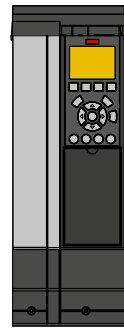
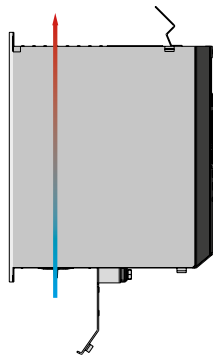

A3 with IP21/Type 12 NEMA 1 Kit

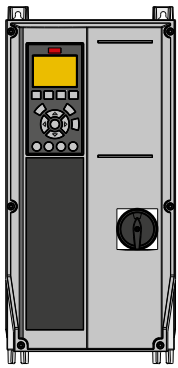
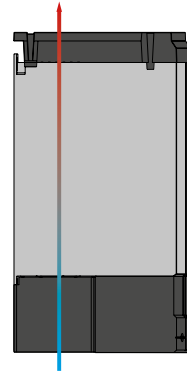

A4 IP55 with mains disconnect

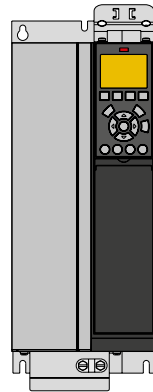
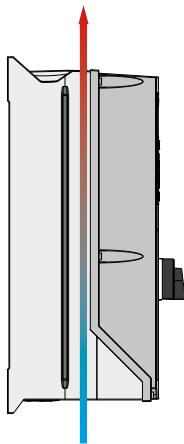

B3 IP20

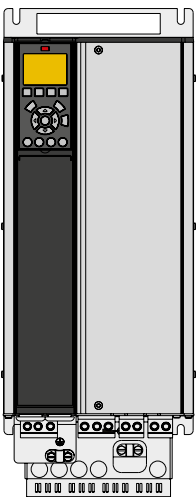
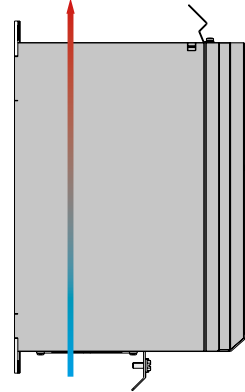

B4 IP20

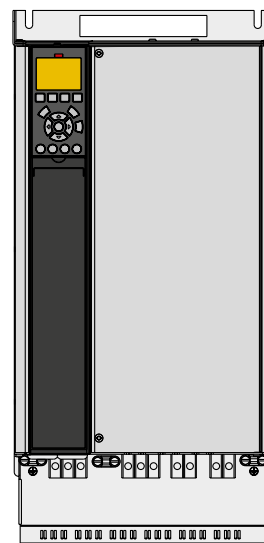
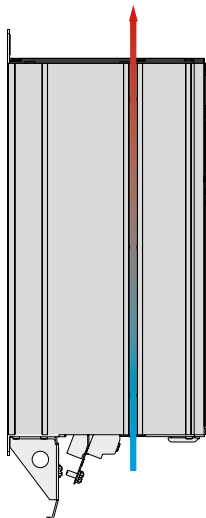

C3 IP20

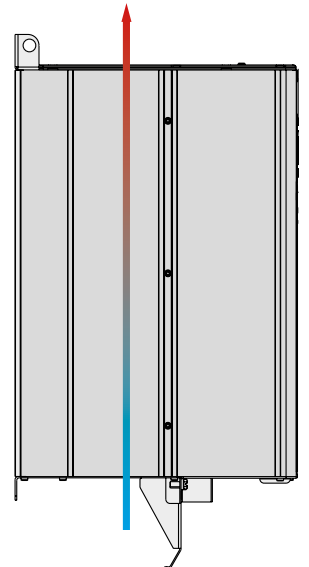

Please see the VLT® HVAC Drive FC 102 Design Guide for other enclosure types, available at <http://www.danfoss.com/Products/Literature/VLT+Technical+Documentation.htm>

Enclosure types A, B and C

		VLT® HVAC Drive													
Enclosure type		A2		A3		A4	A5	B1	B2	B3	B4	C1	C2	C3	C4
Protection rating		IP20	IP21	IP20	IP21	IP55/IP66		IP21/IP55/IP66		IP20		IP21/IP55/IP66		IP20	
H mm	Height of back plate	268	375	268	375	390	420	480	650	399	520	680	770	550	660
H1 mm	With de-coupling plate for fieldbus cables	374	-	374	-	-	-	-	-	420	595	-	-	630	800
H2 mm	Distance to mounting holes	254	350	257	350	401	402	454	624	380	495	648	739	521	631
W mm		90	90	130	130	200	242	242	242	165	230	308	370	308	370
W1 mm	Distance between mounting holes	70	70	110	110	171	215	210	210	140	200	272	334	270	330
D mm	Depth without option A/B	205	207	205	207	175	195	260	260	249	242	310	335	333	333
D1 mm	With mains disconnect	-	-	-	-	206	224	289	290	-	-	344	378	-	-
D2 mm	With option A/B	220	222	220	222	175	195	260	260	262	242	310	335	333	333
Air cooling	I (air space inlet) mm (inches)	100	100	100	100	100	100	200	200	200	200	200	225	200	225
	O (air space outlet) mm (inches)	100	100	100	100	100	100	200	200	200	200	200	225	200	225
Weight (kg)		4.9	5.3	6.6	7	9.7	13.5/ 14.2	23	27	12	23.5	45	65	35	50

A3 IP20

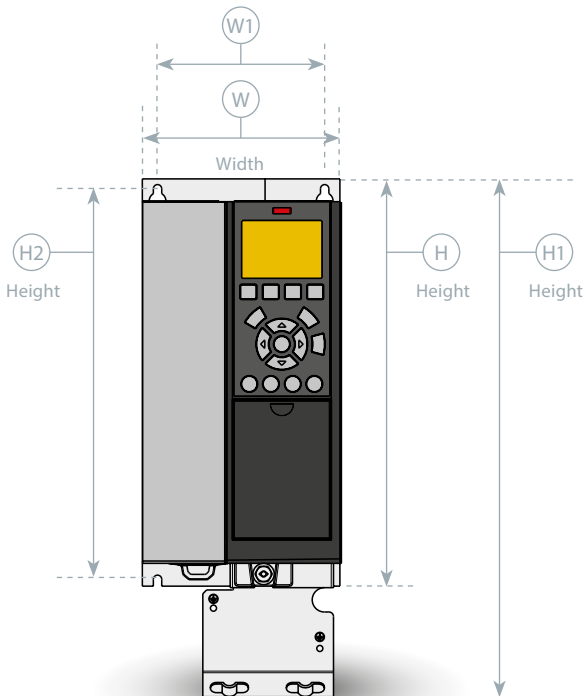

A4 IP55 with mains disconnect

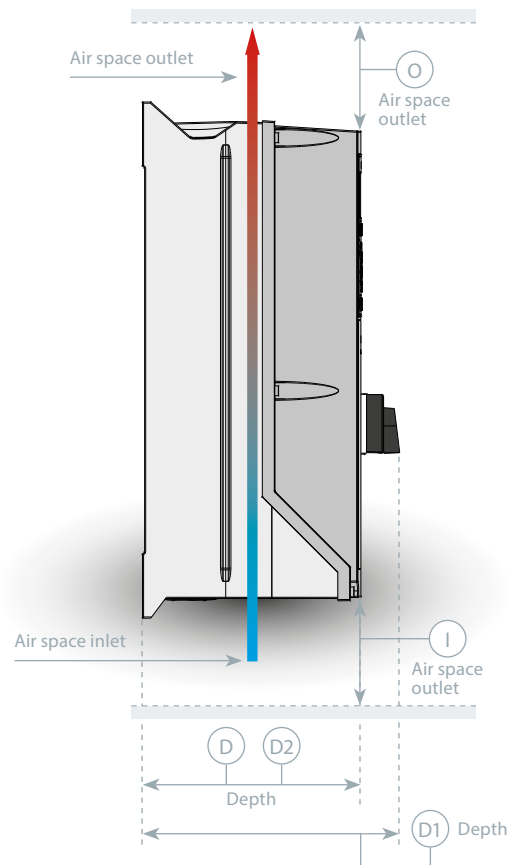

Dimensions and air flow

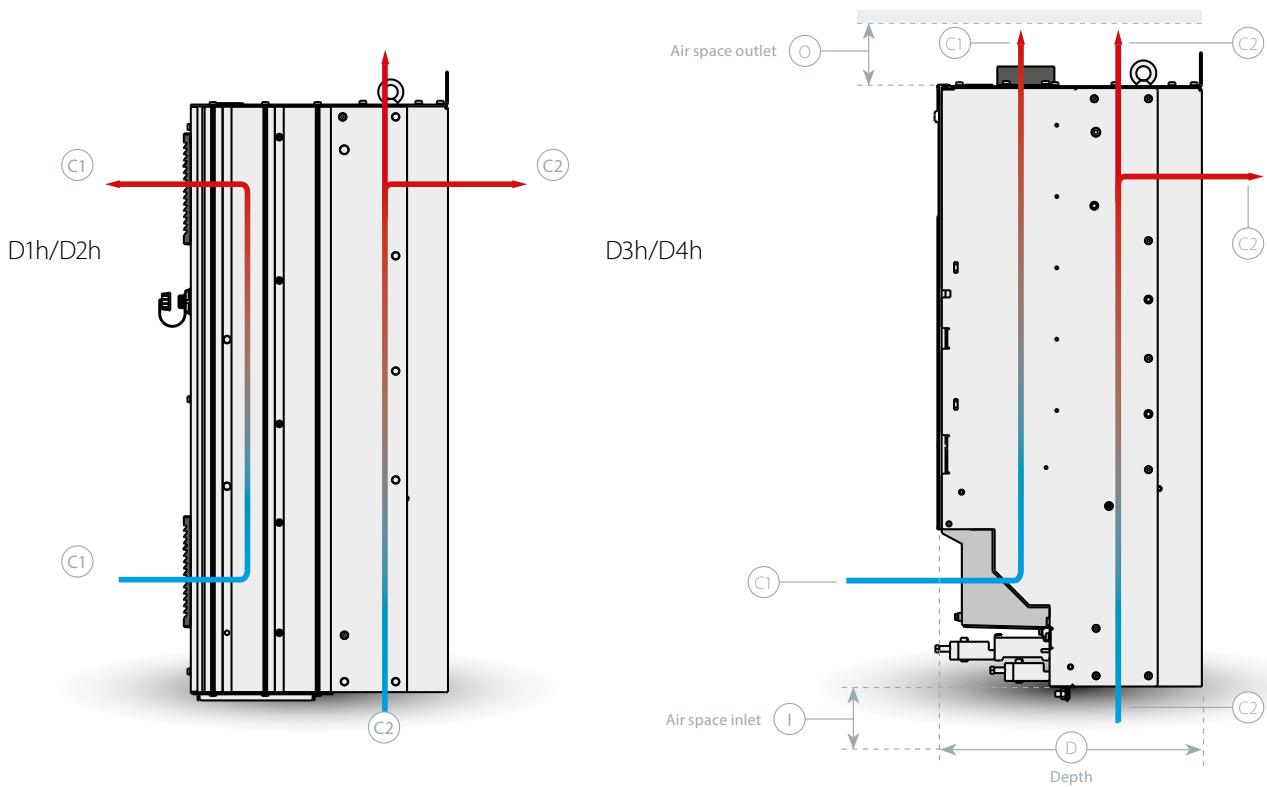
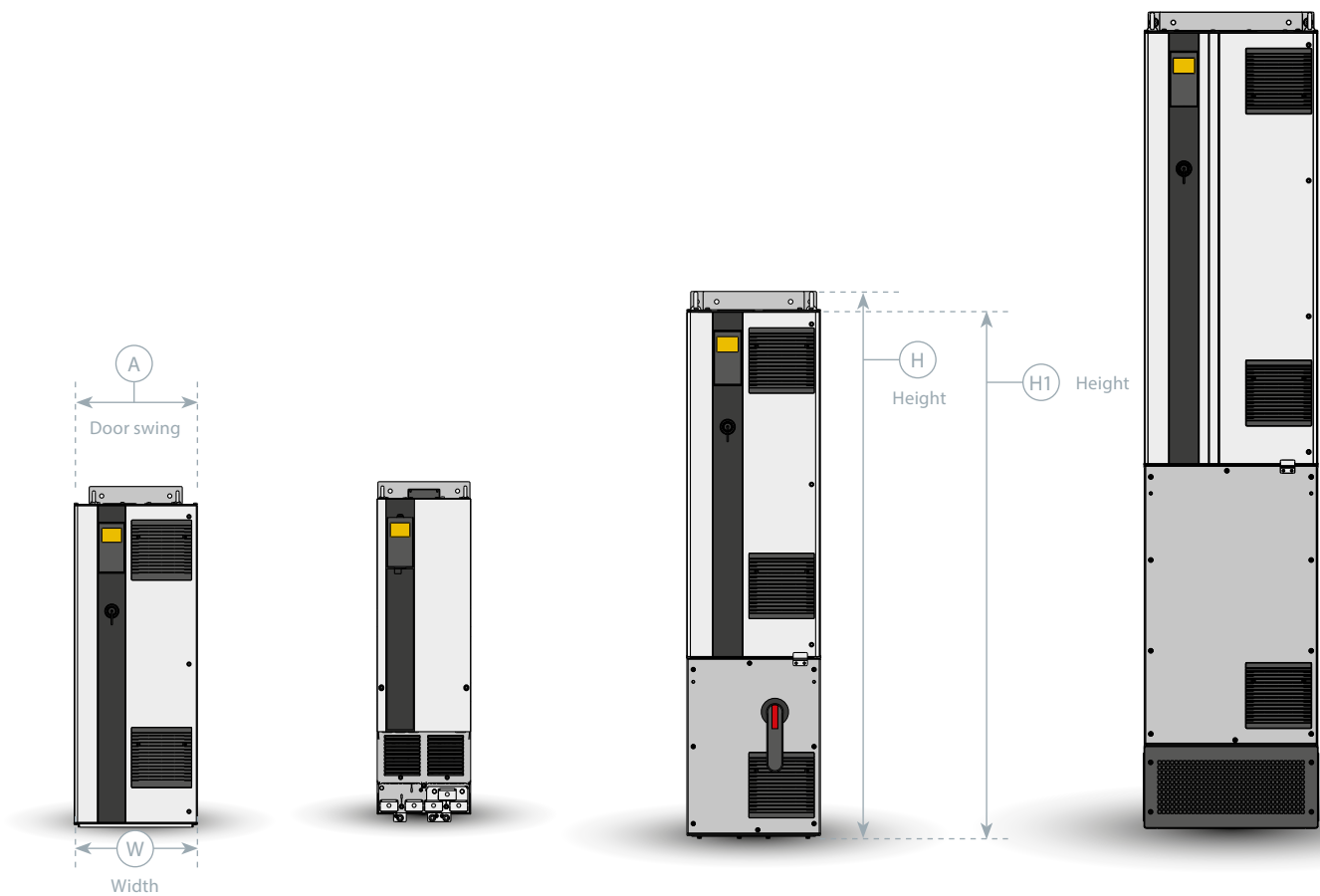

Please see the VLT® High Power Design Guide for other enclosure types, available at <http://www.danfoss.com/Products/Literature/VLT+Technical+Documentation.htm>

Enclosure type D

		VLT® HVAC Drive							
Enclosure type		D1h	D2h	D3h	D4h	D5h	D6h	D7h	D8h
Protection rating		IP21/IP54		IP20		IP21/IP54			
H mm Height of back plate		901	1107	909	1122	1324	1665	1978	2284
H1 mm Height of product		844	1050	844	1050	1277	1617	1931	2236
W mm		325	420	250	350	325	325	420	420
D mm		378	378	375	375	381	381	384	402
D1 mm With mains disconnect		-	-	-	-	426	426	429	447
Door swing A mm		298	395	n/a	n/a	298	298	395	395
Air cooling	I (air space inlet) mm	225	225	225	225	225	225	225	225
	O (air space outlet) mm	225	225	225	225	225	225	225	225
	C1	102 m³/h (60 cfm)	204 m³/h (120 cfm)	102 m³/h (60 cfm)	204 m³/h (120 cfm)	102 m³/h (60 cfm)		204 m³/h (120 cfm)	
	C2	420 m³/h (250 cfm)	840 m³/h (500 cfm)	420 m³/h (250 cfm)	840 m³/h (500 cfm)	420 m³/h (250 cfm)		840 m³/h (500 cfm)	

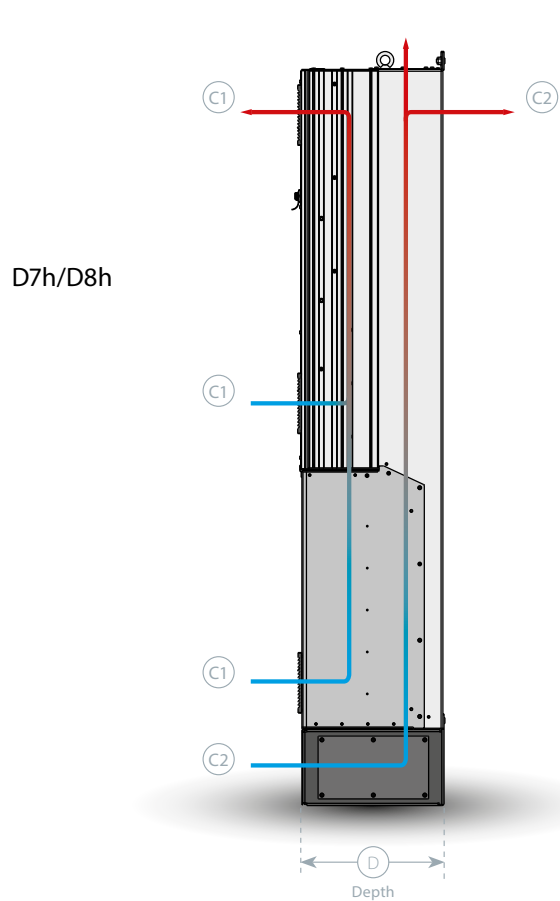
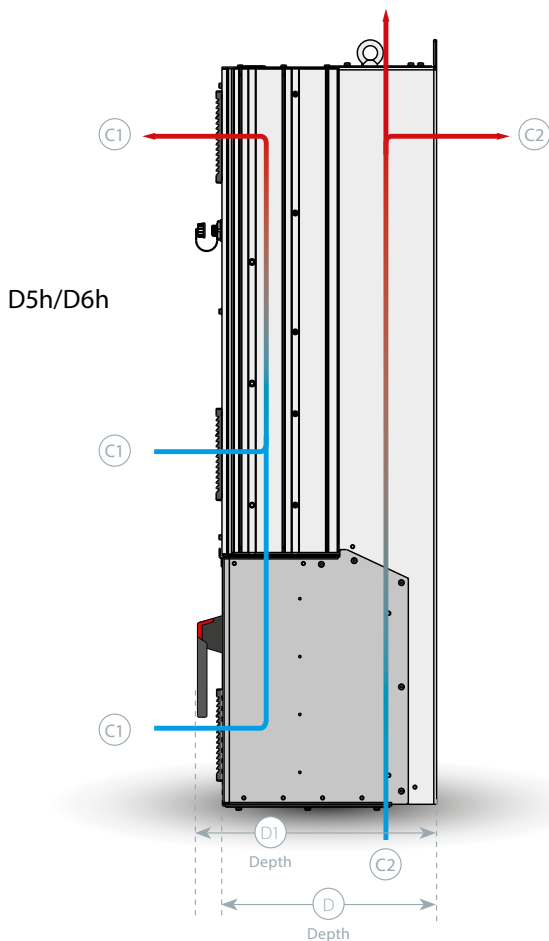



A options: Fieldbuses

For A, B, C and D enclosure types

Fieldbus

A

- VLT® PROFIBUS DP V1 MCA 101
- VLT® DeviceNet MCA 104
- VLT® LonWorks MCA 108
- VLT® BACnet MCA 109
- VLT® PROFINET MCA 120
- VLT® EtherNet/IP MCA 121
- VLT® Modbus TCP MCA 122
- VLT® BACnet/IP MCA 125

VLT® PROFIBUS DP MCA 101

Operating the AC drive via a fieldbus enables you to reduce the cost of your system, communicate faster and more efficiently, and benefit from an easier user interface.

VLT® PROFIBUS DP MCA 101 provides

- Wide compatibility, a high level of availability, support for all major PLC vendors, and compatibility with future versions
- Fast, efficient communication, transparent installation, advanced diagnosis and parameterization and auto-configuration of process data via GSD-file
- Acyclic parameterization using PROFIBUS DP-V1, PROFIdrive or Danfoss FC profile state machines, PROFIBUS DP-V1, Master Class 1 and 2

Ordering number

130B1100 standard, 130B1200 coated

VLT® DeviceNet MCA 104

VLT® DeviceNet MCA 104 offers robust, efficient data handling thanks to advanced Producer/Consumer technology.

- Support of ODVA's AC drive profile supported via I/O instance 20/70 and 21/71 secures compatibility to existing systems
- Benefit also from ODVA's strong conformance testing policies, which ensure that products are interoperable

Ordering number

130B1102 standard, 130B1202 coated

VLT® LonWorks MCA 108

LonWorks is a fieldbus system developed for building automation. It enables communication between individual units in the same system (peer-to-peer) and thus supports decentralizing of control.

- No need for main station (master-follower)
- Units receive signals directly
- Supports Echelon free-topology interface (flexible cabling and installation)
- Supports embedded I/O and I/O options (easy implementation of de-central I/O)
- Sensor signals can quickly be moved to another controller via bus cables
- Certified as compliant with LonMark ver. 3.4 specifications

Ordering number

130B1106 standard, 130B1206 coated

VLT® BACnet MCA 109

The BACnet protocol is an international protocol that efficiently integrates all parts of building automation equipment from the actuator level to the building management system.

Via the BACnet option it is possible to read all analog and digital inputs and control all analog and digital outputs of the VLT® HVAC Drive. All inputs and outputs can be operated independently of the functions of the drive, and thus work as remote I/O:

- COV (Change of Value)
- Synchronization of RTC from BACnet
- Read/write Property Multiple
- Alarm/Warning handling

Ordering number
130B1144 standard, 130B1244 coated

VLT® PROFINET MCA 120

VLT® PROFINET MCA 120 uniquely combines the highest performance with the highest degree of openness. The option is designed so that many of the features from the VLT® PROFIBUS MCA 101 can be reused, minimizing user effort to migrate PROFINET, and securing the investment in a PLC program.

- Other features:**
- Same PPO types as the MCA 101 PROFIBUS for easy migration to PROFINET
 - Built-in web server for remote diagnosis and reading out of basic drive parameters
 - Support of MRP
 - Support of DP-V1 Diagnostic allows easy, fast and standardized handling of warning and fault information into the PLC, improving bandwidth in the system

- Support of PROFISAFE when combined with MCB 152
- Implementation in accordance with Conformance Class B

Ordering number
130B1135 standard, 130B1235 coated

VLT® EtherNet/IP MCA 121

Ethernet is the future standard for communication at the factory floor. The VLT® EtherNet/IP MCA 121 is based on the newest technology available for industrial use and handles even the most demanding requirements. EtherNet/IP extends commercial off-the-shelf Ethernet to the Common Industrial Protocol (CIP™) – the same upper-layer protocol and object model found in DeviceNet.

- The MCA 121 offers advanced features such as:
- Built-in high performance switch enabling line-topology, and eliminating the need for external switches
 - DLR Ring (from October 2015)
 - Advanced switch and diagnosis functions
 - Built-in web server
 - E-mail client for service notification
 - Unicast and Multicast communication

Ordering number
130B1119 standard, 130B1219 coated

VLT® Modbus TCP MCA 122

Modbus TCP is the first industrial Ethernet-based protocol for automation. The VLT® Modbus TCP MCA 122 connects to Modbus TCP-based networks. It is able to handle connection intervals down to 5 ms

in both directions, positioning it among the fastest performing Modbus TCP devices in the market. For master redundancy it features hot swapping between two masters.

- Other features:**
- Built-in web-server for remote diagnosis and reading out basic drive parameters
 - Email notification can be configured, to send an email message to one or more recipients, when certain alarms or warnings occur, or are cleared
 - Dual Master PLC connection for redundancy

Ordering number
130B1196 standard, 130B1296 coated

VLT® BACnet/IP MCA 125

The VLT® BACnet/IP MCA 125 option optimizes the use of VLT® HVAC Drive together with building management systems (BMS) using the BACnet/IP protocol or running BACnet on Ethernet. The option has two Ethernet connectors, enabling daisy-chain configuration with no need for external switches. The VLT® BACnet/IP MCA 125 makes it easy to control or monitor points required in typical HVAC applications, and reduces overall cost of ownership.

- Besides standard functionality, the option provides:
- COV, Change Of Value
 - Read/WritePropertyMultiple
 - Alarm/Warning notifications
 - PID Loop object
 - Segmented data transfer
 - Trending

Ordering number
134B1586 coated



B options: Functional extensions

For A, B, C and D enclosure types

Functional extensions
B
VLT® General Purpose MCB 101
VLT® Relay Option MCB 105
VLT® Analog I/O Option MCB 109
VLT® PTC Thermistor Card MCB 112
VLT® Sensor Input Card MCB 114
VLT® Safe Option MCB 140 Series

VLT® General Purpose I/O MCB 101

This I/O option offers an extended number of control inputs and outputs:

- 3 digital inputs 0-24 V:
Logic '0' < 5 V; Logic '1' > 10V
- 2 analogue inputs 0-10 V:
Resolution 10 bit plus sign
- 2 digital outputs NPN/PNP push pull
- 1 analogue output 0/4-20 mA
- Spring loaded connection

Ordering number
130B1125 standard, 130B1212 coated

VLT® Relay Option MCB 105

Makes it possible to extend relay functions with 3 additional relay outputs.

- Max switch rate at rated load/min. load6 min⁻¹/20 sec⁻¹
- Protects control cable connection
- Spring-loaded control wire connection

- Max. terminal load:**
- AC-1 Resistive load240 V AC 2 A
 - AC-15 Inductive load @cos phi 0.4240 V AC 0.2 A
 - DC-1 Resistive load24 V DC 1 A
 - DC-13 Inductive load @cos phi 0.424 V DC 0.1 A

- Min. terminal load:**
- DC 5 V10 mA

Ordering number
130B1110 standard, 130B1210 coated

VLT® Analog I/O Option MCB 109

This analog input/output option is easily fitted in the AC drive for upgrading to advanced performance and control using the additional I/O. This option also upgrades the AC drive with a battery back-up supply for the AC drive built-in clock. This provides stable use of all AC drive clock functions as timed actions.

- 3 analog inputs, each configurable as both voltage and temperature input
- Connection of 0-10 V analog signals as well as PT1000 and NI1000 temperature inputs
- 3 analog outputs each configurable as 0-10 V outputs
- Back-up supply for the standard clock function in the AC drive

The back-up battery typically lasts for 10 years, depending on environment.

Ordering number
130B1143 standard, 130B1243 coated

B options: Functional extensions

For A, B, C and D enclosure types



VLT® PTC Thermistor Card MCB 112

The VLT® PTC Thermistor Card MCB 112 enables improved surveillance of the motor condition compared to the built-in ETR function and thermistor terminal.

- Protects the motor from overheating
- ATEX-approved for use with Ex d and Ex e motors (EX e only FC 302)
- Uses Safe Stop function, which is approved in accordance with SIL 2 IEC 61508

Ordering number

NA standard, 130B1137 coated

VLT® Sensor Input Card MCB 114

This option protects the motor from being overheated by monitoring the temperature of bearings and windings in the motor.

- Protects the motor from overheating
- Three self-detecting sensor inputs for 2 or 3 wire PT100/PT1000 sensors
- One additional analog input 4-20 mA

Ordering number

130B1172 standard, 130B1272 coated

VLT® Safe Option MCB 140 Series

VLT® Safety Option MCB 140 and MCB 141 comprise safety options with Safe Stop 1 (SS1), Safety Limited Speed (SLS) and Safe Speed Monitor (SSM) functionality.

The options can be used up to PL e according to ISO 13849-1. MCB 140 is a standard B-Option. MCB 141 offers the same functionality in an external 45 mm housing. MCB 141 enables the user to use MCB 140 functionality also if another B-Option is used.

Different operating modes can be easily configured by using the on board display and buttons. The options provide only a limited set of parameters for fast parameterization.

- MCB 140 standard B-Option
- MCB 141 external option
- Single-channel or dual-channel operation possible
- Proximity switch as speed feedback
- SS1, SLS and SMS functionality
- Easy and fast parameterization

Ordering number

130B6443 MCB 140, 130B6447 MCB 141

D option: External power supply

For A, B, C and D enclosure types



Option slot

D

VLT® 24 V DC Supply Option MCB 107

VLT® 24 V DC Supply MCB 107

Connect an external DC supply to keep the control section and any installed option alive during power failure.

This enables full operation of the LCP (including the parameter setting) and all installed options without connection to mains.

- Input voltage range 24 V DC +/- 15% (max. 37 V in 10 sec.)
- Max. input current2.2 A
- Max. cable length75 m
- Input capacitance load< 10 uF
- Power-up delay< 0.6 s

Ordering number

130B1108 standard, 130B1208 coated

Accessories

For A, B, C and D enclosure types

LCP

VLT® Control Panel LCP 101 (Numeric)
Ordering number: 130B1124

VLT® Control Panel LCP 102 (Graphical)
Ordering number: 130B1107

LCP Panel Mounting Kit
Ordering number for IP20 enclosure
130B1113: With fasteners, gasket, graphical LCP and 3 m cable
130B1114: With fasteners, gasket, numerical LCP and 3 m cable
130B1117: With fasteners, gasket and without LCP and with 3 m cable
130B1170: With fasteners, gasket and without LCP

Ordering number for IP55 enclosure
130B1129: With fasteners, gasket, blind cover and 8 m "free end" cable

Power Options*

VLT® Sine-Wave Filter MCC 101

VLT® dU/dt Filter MCC 102

VLT® Common Mode Filters MCC 105

VLT® Advanced Harmonic Filter AHF 005/010

VLT® Brake Resistors MCE 101

Accessories

PROFIBUS SUB-D9 Adapter
IP20, A2 and A3
Ordering number: 130B1112

USB Extension
Ordering number:
130B1155: 350 mm cable
130B1156: 650 mm cable

IP21/Type 1 (NEMA 1) Kit
Ordering number
130B1122: For frame size A2
130B1123: For frame size A3
130B1187: For frame size B3
130B1189: For frame size B4
130B1191: For frame size C3
130B1193: For frame size C4

Motor connector
Ordering number:
130B1065: frame A2 to A5 (10 pieces)

Mains connector
Ordering number:
130B1066: 10 pieces mains connectors IP55
130B1067: 10 pieces mains connectors IP20, IP21

Relays 1 terminal
Ordering number: 130B1069 (10 pieces 3 pole connectors for relay 01)

Relays 2 terminal
Ordering number: 130B1068 (10 pieces 3 pole connectors for relay 02)

Control card terminals
Ordering number: 130B0295

*Ordering number: See relevant Design Guide

Ordering type code for A, B, C and D enclosure types

[1]	[2]	[3]	[4]	[5]	[6]	[7]	[8]	[9]	[10]	[11]	[12]	[13]	[14]	[15]	[16]	[17]	[18]	[19]
FC-																		

[1] Application (character 4-6)	
102	VLT® HVAC Drive FC 102
[2] Power size (character 7-10)	
P1K1	1.1 kW / 1.5 HP
P1K5	1.5 kW / 2.0 HP
P2K2	2.2 kW / 3.0 HP
P3K0	3.0 kW / 4.0 HP
P3K7	3.7 kW / 5.0 HP
P4K0	4.0 kW / 5.5 HP
P5K5	5.5 kW / 7.5 HP
P7K5	7.5 kW / 10 HP
P11K	11 kW / 15 HP
P15K	15 kW / 20 HP
P18K	18.5 kW / 25 HP
P22K	22 kW / 30 HP
P30K	30 kW / 40 HP
P37K	37 kW / 50 HP
P45K	45 kW / 60 HP
P55K	55 kW / 75 HP
P75K	75 kW / 100 HP
P90K	90 kW / 125 HP
N55K	55 kW / 75 HP
N75K	75 kW / 100 HP
N90K	90 kW / 125 HP
N110	110 kW / 150 HP
N132	132 kW / 200 HP
N160	160 kW / 250 HP
N200	200 kW / 300 HP
N250	250 kW / 350 HP
N315	315 kW / 450 HP
N400	400 kW / 550 HP
[3] AC Line Voltage (character 11-12)	
T2	3 x 200/240 V AC (1.1 – 45 kW)
T4	3 x 380/480 V AC (1.1 – 1000 kW)
T6	3 x 525/600 V AC (1.1 – 90 kW)
T7	3 x 525/690 V AC (1.1 – 1400 kW)
[4] Enclosure (character 13-15)	
For cabinet mounting:	
E20	IP20/Chassis (frame A2, A3, B3, B4, C3, C4, D3h, D4h)
Standalone:	
E21	IP21 /Type 1 (frame B1, B2, C1, C2, D1h, D2h, D5h, D6h, D7h, D8h)
E3R	Type 3R*
E54	IP54/Type 12 (frame D1h, D2h, D5h, D6h, D7h, D8h)
E55	IP55 (frame A5, B1, B2, C1, C2)
E66	IP66/Type 4X outdoor* – frame A5, B1, B2, C1, C2)
Z55	IP55/Type 12 (frame A4)
Z66	IP66/NEMA 4X* (frame A4)
Special designs:	
P20	IP20 (frame B4, C3, C4 – with back plate)
P3R	Type 3R with back plate*
E2M	IP21 /Type 1 with mains shield (frame D1h, D2h, D5h, D6h, D7h, D8h)
P21	IP21 /Type 1 (frame as E21 – with back plate)

* Only available in the USA

E5M	IP54 /Type 12 with mains shield (frame D1h, D2h, D5h, D6h, D7h, D8h)
P55	IP55 (frame as E55 – with back plate)
Y55	IP55 (frame as Z55 – with back plate)
Y66	IP66/NEMA 4X* (frame as Z66 – with back plate)
[5] RFI filter, terminal and monitoring options – EN/IEC 61800-3 (character 16-17)	
H1	RFI-Filter Class A1/B (C1) (A, B and C frames only)
H2	RFI-Filter, Class A2 (C3)
H3	RFI-Filter Class A1/B ¹⁾ (A, B and C frames only)
H4	RFI-Filter, Class A1 (C2) (B, C and D frames only)
H5	RFI-Filter, Class A2 (C3) Marine ruggedized
HX	No RFI-Filter (only 600 V) (A, B and C frames only)
[6] Braking and safety (character 18)	
X	No brake IGBT
B	Brake IGBT
T	Safe Stop without brake
R	Regeneration terminals (D frame only)
U	Brake IGBT plus Safe Stop
[7] LCP Display (character 19)	
X	Blank faceplate, no LCP installed
N	Numerical Local Control Panel (LCP 101)
G	Graphical Local Control Panel (LCP 102)
[8] PCB Coating – IEC 721-3-3 (character 20)	
X	No conformal coating (Class 3C2)
C	Conformal coating on all PCBs (Class 3C3)
R	Conformal coating plus ruggedized
[9] Mains input (character 21)	
X	No mains option
1	Mains disconnect
7	Fuses (D frame only)
8	Mains disconnect and loadsharing (B1, B2, C1 and C2 frames only)
A	Fuses and loadsharing terminals (D frame IP20 only)
D	Loadsharing terminals (B1, B2, C1 and C2 frames only, D-frame only IP20)
3	Mains disconnect + fuse (D frame only)
4	Mains contactor + fuse (D frame only)
5	Mains disconnect, fuse and load sharing
E	Mains disconnect + contactor + fuse (D frame only)
J	Circuit breaker + fuse (D frame only)
[10] Power terminals and motor starters (character 22)	
X	Standard cable entries
O	Metric cable entries
S	US cable entries (not for A4 frame)

[11] Auxiliary 24 V supply and external temperature monitoring (character 23)	
X	No adaptation
Q	Heat-sink access panel (D frame only)
[12] Special version (character 24-27)	
SXXX	No option
[13] LCP language (character 28)	
X	Standard language package including English, German, French, Spanish, Danish, Italian and Finnish
Contact factory for other language options	
[14] Fieldbus (character 29-30)	
AX	No option
A0	VLT® PROFIBUS DP V1 MCA 101
A4	VLT® DeviceNet MCA 104
AG	VLT® LonWorks MCA 108
AJ	VLT® BACnet MCA 109
AK	VLT® BACnet/IP MCA 125
AL	VLT® PROFINET MCA 120
AN	VLT® EtherNet/IP MCA 121
AQ	VLT® Modbus TCP MCA 122
[15] Application (character 31-32)	
BX	No application option
BK	VLT® General Purpose MCB 101
BP	VLT® Relay Option MCB 105
BZ	VLT® Safety PLC I/O MCB 108
B0	VLT® Analog I/O Option MCB 109
B2	VLT® PTC Thermistor Card MCB 112
B4	VLT® Sensor Input Card MCB 114
[17] Application (character 35)	
X	No C1 option
R	VLT® Extended Relay Card MCB 113
[19] Control Power Backup Input (character 38-39)	
DX	No DC input installed
D0	VLT® 24 V DC Supply Option MCB 107

1) reduced motor cable length

Please be aware that not all combinations are possible. For assistance in configuring your drive, go to: driveconfig.danfoss.com

Based on your selection, Danfoss manufactures the desired VLT® HVAC Drive. You will receive a fully assembled AC drive, tested under full load conditions.

Power and enclosures

VLT® HVAC Drive		T2 200 – 240 V				T4/T5 380 – 480 V						T6 525 – 600 V				T7 525 – 690 V													
FC 102	kW	A	A				A		A				A		A														
			IP20	IP21	IP55	IP66	≤440V	>440V	IP20	IP21	IP54	IP55	IP66	≤550V	>550V	IP20	IP21	IP55	IP66	550V	690V	IP20	IP21	IP54	IP55	IP66			
P1K1	1.1	6.6					3	2.7							2.6	2.4							2.1	1.6					
P1K5	1.5	7.5	A2	A2	A4/A5	A4/A5	4.1	3.4							2.9	2.7							2.7	2.2					
P2K2	2.2	10.6					5.6	4.8	A2	A2					4.1	3.9	A3	A3	A5	A5			3.9	3.2	A3	A3		A5	A5
P3K0	3.0	12.5	A3	A3	A5	A5	7.2	6.3							5.2	4.9							4.9	4.5					
P3K7	3.7	16.7																											
P4K0	4.0						10	8.2	A2	A2					6.4	6.1							6.1	5.5					
P5K5	5.5	24.2					13	11	A3	A3					9.5	9	A3	A3	A5	A5			9	7.5	A3	A3		A5	A5
P7K5	7.5	30.8	B3	B1	B1	B1	16	14.5							11.5	11							11	10					
P11K	11	46.2					24	21							19	18							14	13					
P15K	15	59.4					32	27	B3	B1					23	22	B3	B1	B1	B1			19	18					
P18K	18.5	74.8	B4	B2	B2	B2	37.5	34							28	27							23	22	B4	B2		B2	
P22K	22	88					44	40							36	34							28	27					
P30K	30	115	C3	C1	C1	C1	61	52	B4	B2					43	41	B4	B2	B2	B2			36	34					
P37K	37	143					73	65							54	52							43	41					
P45K	45	170	C4	C2	C2	C2	90	80	C3	C1					65	62	C3	C1	C1	C1			54	52	C3	C2		C2	
P55K	55						106	105							87	83							65	62					
P75K	75						147	130							105	100							87	83					
P90K	90						177	160							137	131							105	100					
N75K*	75																						90	86					
N90K*	90																						113	108					
N110	110						212	190															137	131	D3h	D1h D5h D6h	D1h D5h D6h		
N132	132						260	240	D3h	D1h D5h D6h	D1h D5h D6h											162	155						
N160	160						315	302															201	192					
N200	200						395	361															253	242					
N250	250						480	443	D4h	D2h D7h D8h	D2h D7h D8h											303	290	D4h	D2h D7h D8h	D2h D7h D8h			
N315	315						588	535															360	344					
N400*	400																						418	400					

* Only available in 690 V

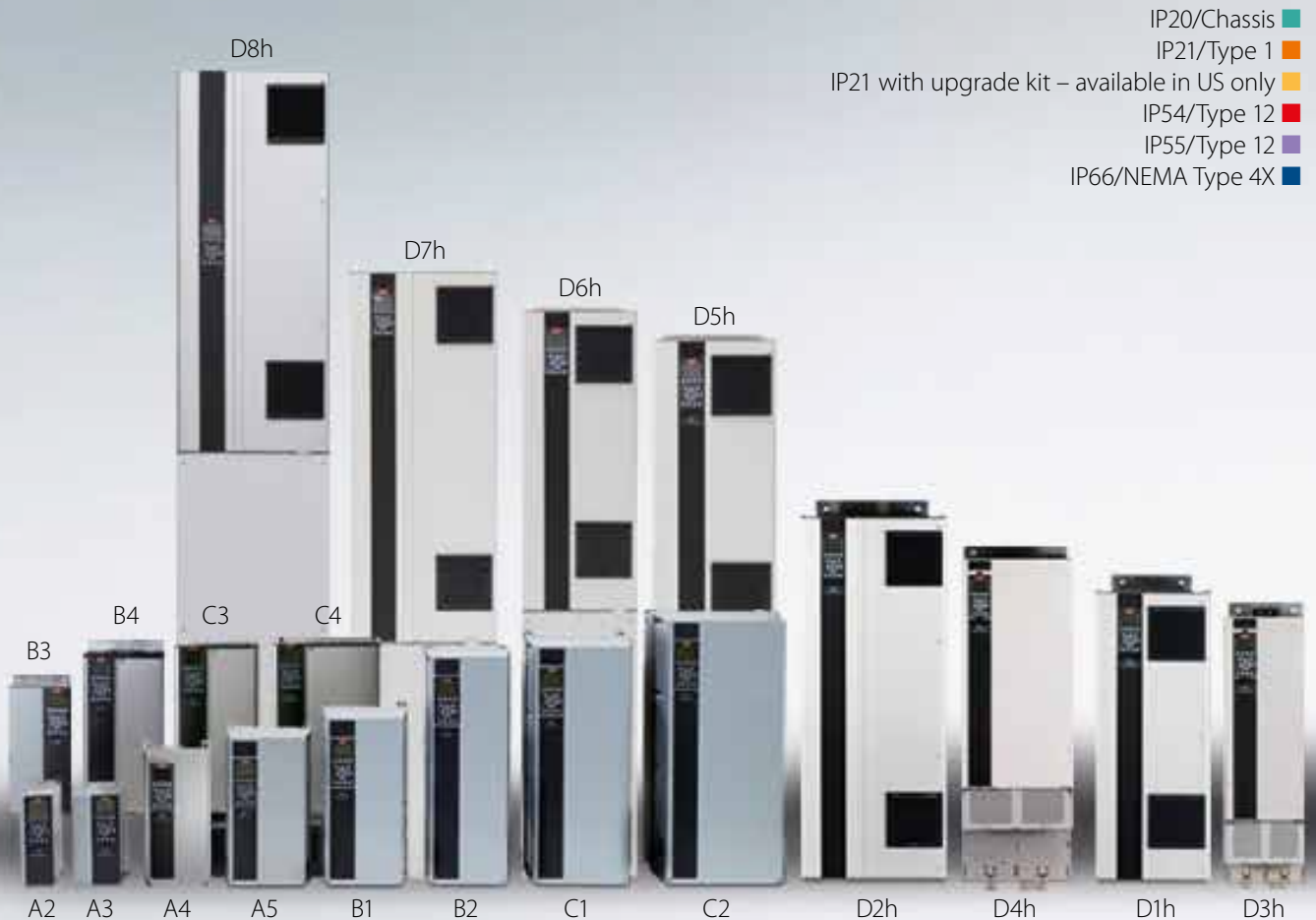



Danfoss Drives

Danfoss Drives is a world leader in variable speed control of electric motors. We aim to prove to you that a better tomorrow is driven by drives. It is as simple and as ambitious as that.

We offer you unparalleled competitive edge through quality, application-optimized products targeting your needs – and a comprehensive range of product lifecycle services.

You can rely on us to share your goals. Striving for the best possible performance in your applications is our focus. We achieve this by providing the innovative products and application know-how required to optimize efficiency, enhance usability, and reduce complexity.

From supplying individual drive components to planning and delivering complete drive systems; our experts are ready to support you all the way.

We draw on decades of experience within industries that include:

- Chemical
- Cranes and Hoists
- Food and Beverage
- HVAC
- Lifts and Escalators
- Marine and Offshore
- Material Handling
- Mining and Minerals
- Oil and Gas
- Packaging
- Pulp and Paper
- Refrigeration
- Water and Wastewater
- Wind

You will find it easy to do business with us. Online, and locally in more than 50 countries, our experts are never far away, reacting fast when you need them.

Since 1968, we have been pioneers in the drives business. In 2014, Vacon and Danfoss merged, forming one of the largest companies in the industry. Our AC drives can adapt to any motor technology and we supply products in a power range from 0.18 kW to 5.3 MW.

VLT® | VAGON®

Danfoss can accept no responsibility for possible errors in catalogues, brochures and other printed material. Danfoss reserves the right to alter its products without notice. This also applies to products already on order provided that such alterations can be made without subsequential changes being necessary in specifications already agreed. All trademarks in this material are property of the respective companies. Danfoss and the Danfoss logotype are trademarks of Danfoss A/S. All rights reserved.